

9160+840

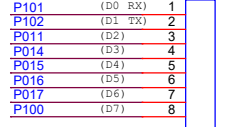

(ARDUINO)

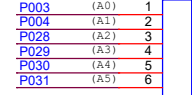
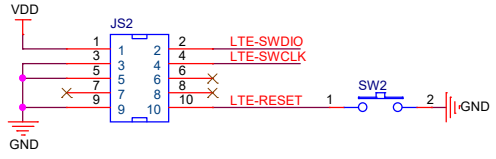
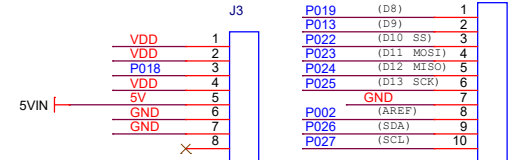
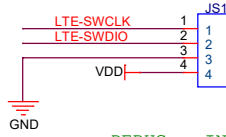
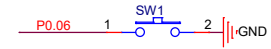
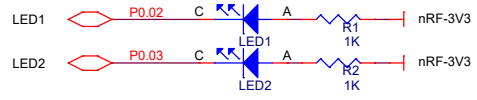
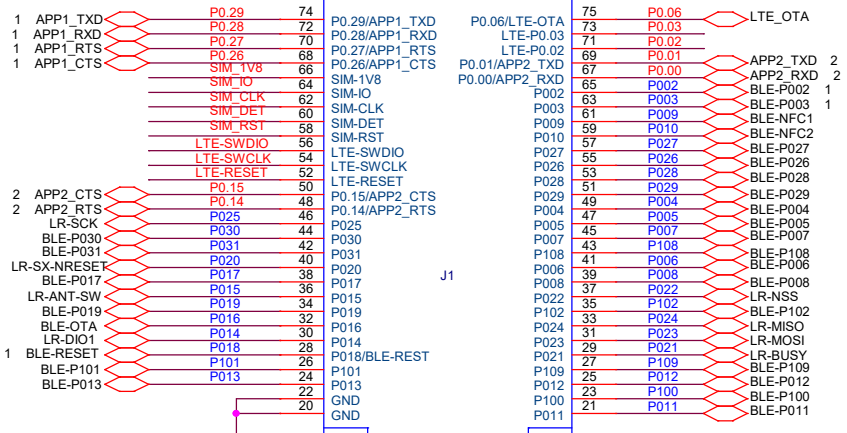
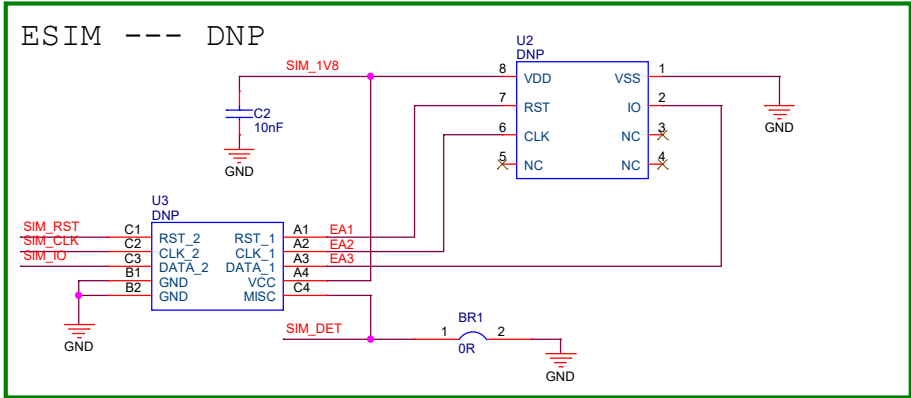
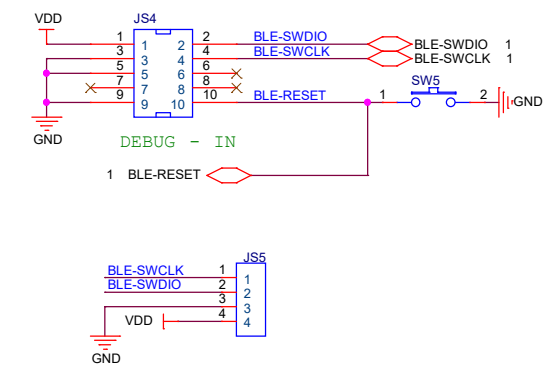
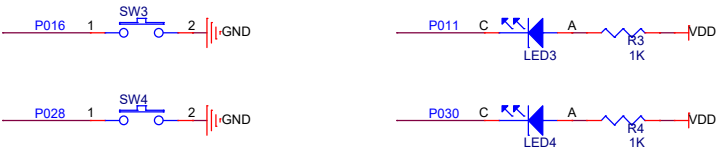
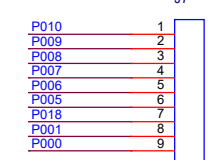
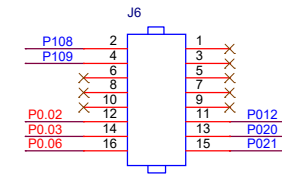
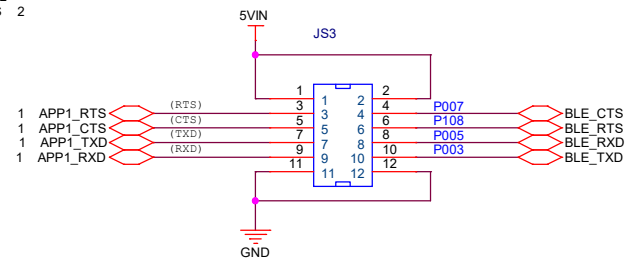
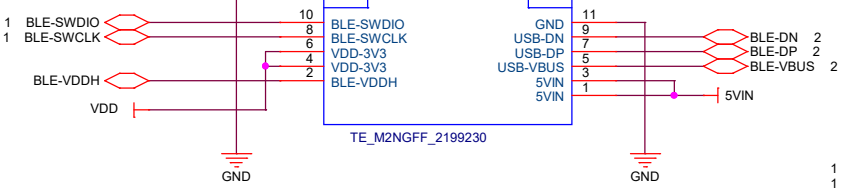

FANSTEL Corporation.		
Title		
BN60E840 Module EVM		
Size	Document Number	Rev
B	nRF9160 + BLE	1.2
Date:	Wednesday, July 15, 2020	Sheet 1 of 2

