

# PARTIAL TEST REPORT

of

## RE Directive (2014/53/EU)

### ETSI EN 300 328 v2.2.2

**Product:** Bluetooth 5.0 Module

**Brand:** Fanstel

**Model:** BT840X, BT840XE

**Model Difference:** Please see page 5 model summaries table

**Applicant:** Fanstel Corporation, Taipei

**Address:** 10F-10, No. 79, Sec. 1, Hsin Tai Wu Rd.,  
Hsi-Chih, New Taipei City 221 Taiwan

**Test Performed by:**  
**International Standards Laboratory Corp.**

<LT Lab.>

\*Address:

No. 120, Lane 180, Hsin Ho Rd.

Lung-Tan Dist., Tao Yuan City 325, Taiwan

\*Tel : 886-3-407-1718; Fax: 886-3-407-1738

**Report No.: ISL-19LR022E328-R1**

**Issue Date : 2021/01/15**



Test results given in this report apply only to the specific sample(s) tested and are traceable to national or international standard through calibration of the equipment and evaluating measurement uncertainty herein.

The determination of the test results is determined by customer agreement, regulations or standard document specifications. The uncertainty of the measurement does not include in consideration of the test result unless the customer required the determination of uncertainty via the agreement, regulation or standard document specification.

This test report shall not be reproduced except in full, without the written approval of International Standards Laboratory Corp.

## VERIFICATION OF COMPLIANCE

**Applicant:** Fanstel Corporation, Taipei  
**Equipment Under Test:** Bluetooth 5.0 Module  
**Brand Name:** Fanstel  
**Model Number:** BT840X, BT840XE  
**Model Different:** Please see page 5 model summaries table  
**Date of Test:** 2020/12/01 ~ 2020/12/16  
**Date of EUT Received:** 2020/12/01

APPLICABLE STANDARDS
ETSI EN 300 328 V2.2.2
This report only covers partial test item, including EIRP, Tx RSE, and Receiver Blocking

The above equipment was tested by International Standards Laboratory Corp. for compliance with the requirements set forth in the European Standard ETSI EN 300328 V V2.2.2. under article 3.2 of RE Directive 2014/53/EU. The results of testing in this report apply to the product/system that was tested only. Other similar equipment will not necessarily produce the same results due to production tolerance and measurement uncertainties.

<i>Test By:</i>	 <hr style="border: 0.5px solid black;"/> <i>Weitin Chen / Senior Engineer</i>	<i>Date:</i>	2021/01/15 <hr style="border: 0.5px solid black;"/>
<i>Prepared By:</i>	 <hr style="border: 0.5px solid black;"/> <i>Elisa Chen / Senior Engineer</i>	<i>Date:</i>	2021/01/15 <hr style="border: 0.5px solid black;"/>
<i>Approved By:</i>	 <hr style="border: 0.5px solid black;"/> <i>Jerry Liu / Associate Director</i>	<i>Date:</i>	2021/01/15 <hr style="border: 0.5px solid black;"/>

## Version

Version No.	Date	Description
00	2021/01/15	Initial creation of document

## TABLE OF CONTENTS

1. Description of Equipment under Test (EUT) .....	5
2. Description of Test Modes .....	7
3. General Description of Applied Standards.....	8
4. Test Facility .....	8
5. Block Diagram of Test Setup .....	9
6. RF Output Power .....	15
7. Transmitter Unwanted Emissions in the Spurious Domain .....	17
8. Receiver Blocking.....	20
PHOTOGRAPHS OF SET UP .....	26
PHOTOGRAPHS OF EUT.....	29

## 1. Description of Equipment under Test (EUT)

General:

Product Name:	Bluetooth 5.0 Module
Brand:	Fanstel
Model:	BT840X, BT840XE
Model different:	Please see model summaries table below
Power Supply:	5Vdc
Type of Equipment:	Embed Modular
Temperature Range:	-40°C to + 85°C
Geo-location capability:	no
Simultaneous transmissions:	N/A

### Model Summaries

module	BT840X	BT840XE
SoC	nRF52840-QIAA	nRF52840-QIAA
Size	15x20.8x1.9mm	15x20.8x1.9mm
BT Antenna	PCB trace	PA + u.FL
32.768 sleep crystal	Integrated	Integrated
BT range, 1 Mbps, LMPI		
BT range, 1Mbps, 1.52m		
BT range, 125 Kbps, LMPI.		
BT range, 125 kBps, 1.52m		
Availability	Sample	Sample

BT BLE:

Bluetooth Version	BT 5.0 (GFSK)
Frequency Range:	2402 – 2480MHz
Channel number:	40 channels
Modulation type:	GFSK
Transmit Power: (EIRP)	16.17dBm
Dwell Time:	N/A
Operating Mode:	Point-to-Point
Adaptive/ Non-Adaptive Equipment	Adaptive
Occupied Channel Bandwidth	Within 2400-2483.5MHz
Duty Cycle	N/A
Antenna Beam forming	No
Antenna Designation:	Type: PCB Antenna, BT840X : 0.87 dBi Type: Dipole Antenna, BT840XE : 0 dBi

This test report applies for BT 5.0

## 2. Description of Test Modes

The EUT has been tested under Operating condition. To control the EUT for staying in continuous transmitting and receiving mode is programmed.

Model BT840X is the worst case for testing.

BLE: Lowest (2402MHz), Mid (2442MHz) and Highest (2480MHz) mode.

### **Normal test conditions :**

Refer to section 5.1.1.2 of EN 300328

Temperature : + 15°C to 35 °C

Relative humidity: 20 % to 50 %

Normal Voltage: 5Vdc

### **Extreme test conditions :**

Refer to section 5.1.1.3 of EN 300328

Where tests at extreme temperatures are required, measurements shall be made over the extremes of the operating temperature range as declared by the manufacturer.

Extreme temperatures: -40°C to + 85°C

### **3. General Description of Applied Standards**

The EUT According to the Specifications, it must comply with the requirements of the following standards:

ETSI EN 300 328 V2.2.2 – Wideband transmission systems; Data transmission equipment operating in the 2,4 GHz ISM band; Harmonized Standard for access to radio spectrum

### **4. Test Facility**

International Standards Laboratory Corp.

<LT Lab.>

No. 120, Lane 180, Hsin Ho Rd., Lung-Tan Dist., Tao Yuan City 325, Taiwan

A fully anechoic chamber was used for the radiated spurious emissions test.

TAF Accreditation Lab. Lab number: 0997



## 5. Block Diagram of Test Setup

### 5.1 EUT Configuration

**Fig. 1 Configuration of Tested System**

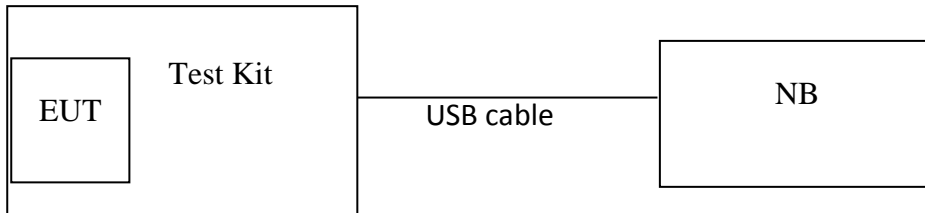
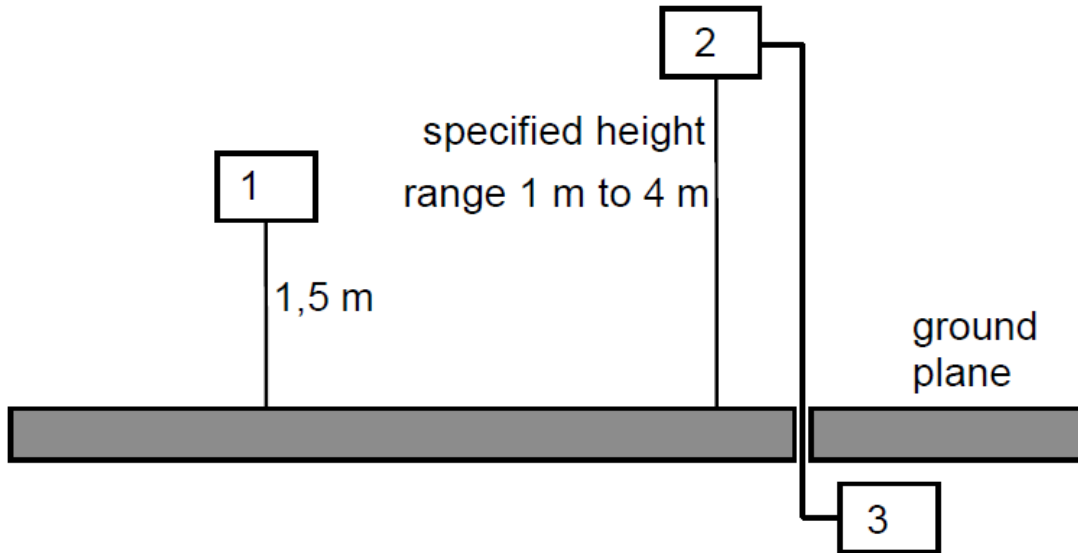

**Table 1 Equipment Used in Tested System**

Item	Equipment	Mfr/Brand	Model/ Type No.	Series No.	Data Cable	Power Cord
1	Notebook	HP	X440i	N/A	N/A	Non-shielded
2	Test Kit	N/A	N/A	N/A	N/A	N/A

## 5.2 Test Setup for ERP/EIRP Measurement

### 5.2.1 Step 1. Field Strength Measurement OATS or SAR test Site



- 1) UUT
- 2) Measurement antenna
- 3) Measurement equipment

### FAR Test Site

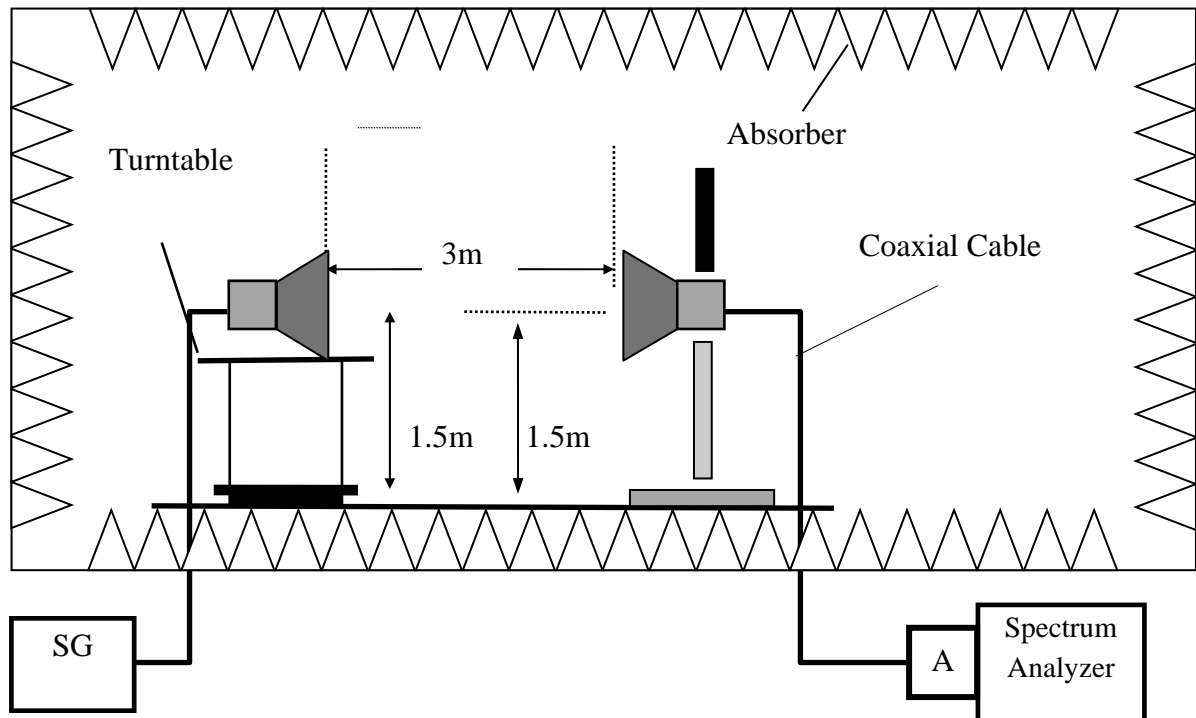

**Step 2. SUBSTITUTION METHOD:**

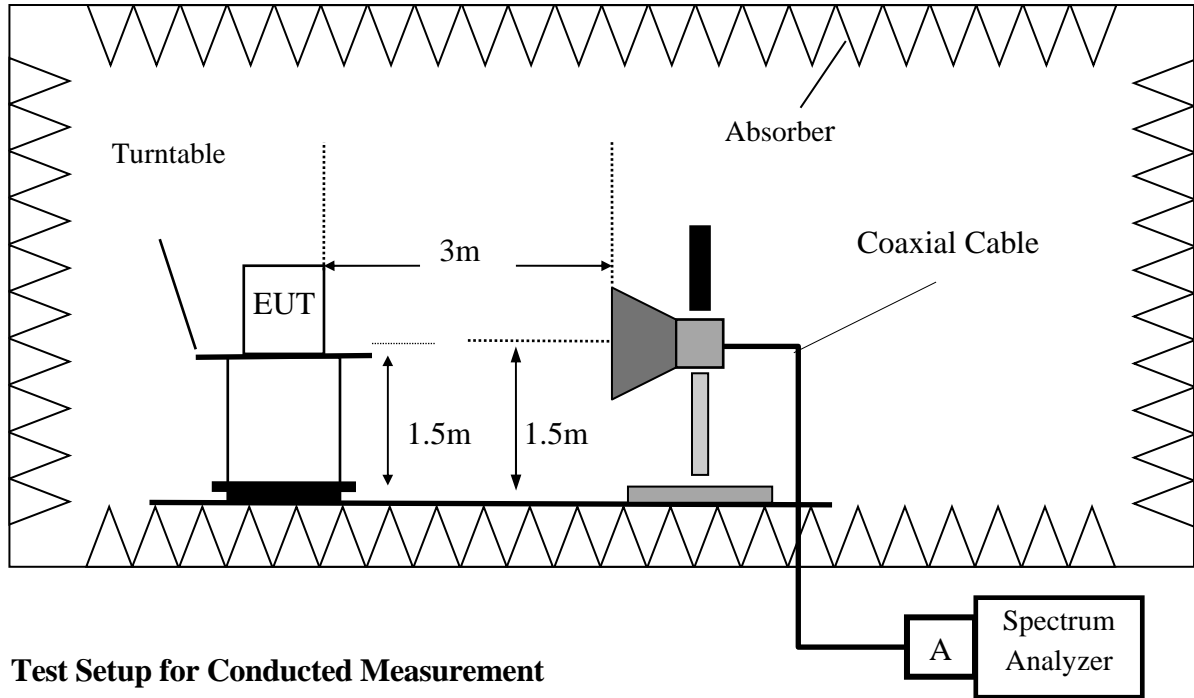

**5.3 Test Setup for Conducted Measurement**

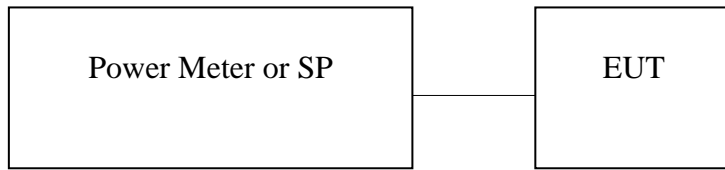

**5.4 Test Setup for Extreme test**

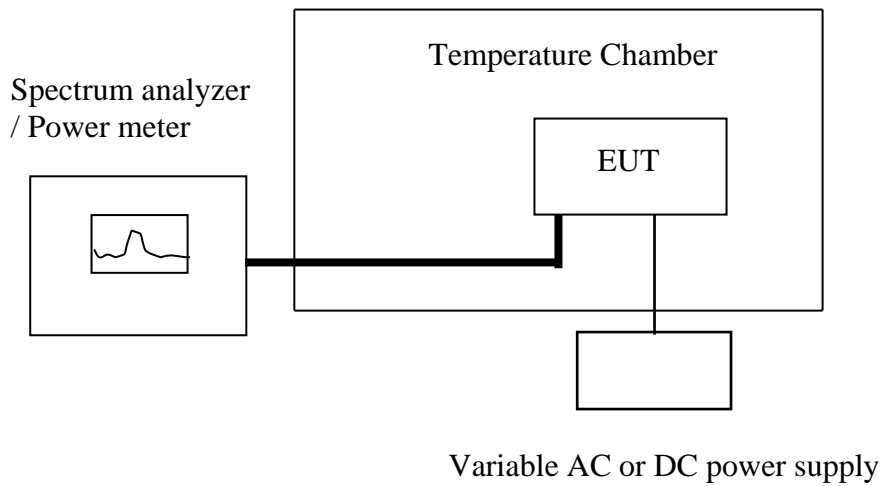

### 5.5 Test Setup for verifying the receiver blocking of an equipment

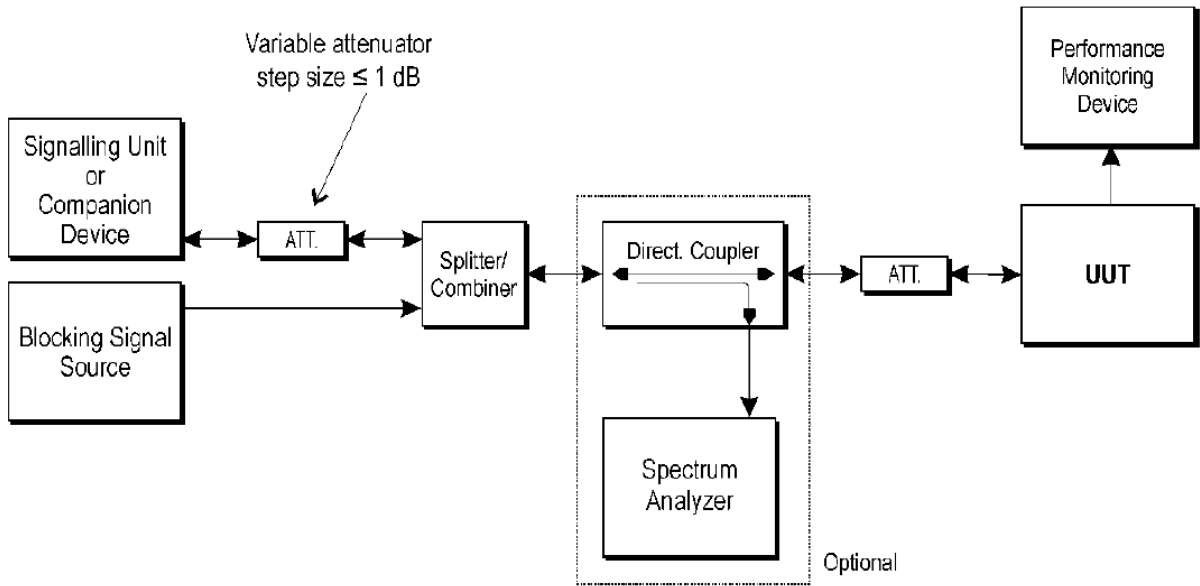

**Figure 6: Test Set-up for receiver blocking**

## 5.6 Measurement Equipment Used:

Location Conducted	Equipment Name	Brand	Model	S/N	Last Cal. Date	Next Cal. Date
Chamber 16	Spectrum Analyzer (26.5GHz)	Agilent	N9010A	MY52100117	09/02/2020	09/02/2021
Chamber 16	Dipole antenna	Schwarzbeck	VHAP,30-300	919	05/11/2020	05/11/2021
Chamber 16	Dipole antenna	Schwarzbeck	UHAP,300-1000	1195	05/11/2020	05/11/2021
Chamber 16	Loop Antenna	EM	EM-6879	271	05/21/2020	05/21/2021
Chamber 16	Bilog Antenna	Schwarzbeck	VULB9168 w 5dB Att.	9168-495	10/14/2020	10/14/2021
Chamber 16	Horn antenna (1GHz - 18GHz)	EM	EM-AH-10180	2011071401	11/23/2020	11/23/2021
Chamber 16	Horn antenna (18GHz - 26GHz)	Com-power	AH-826	081001	11/23/2020	11/23/2021
Chamber 16	Horn antenna (26GHz - 40GHz)	Com-power	AH-640	100A	03/13/2020	03/13/2021
Chamber 16	Preamplifier (9kHz - 1.3GHz)	HP	8447F	3113A04621	06/19/2020	06/19/2021
Chamber 16	Preamplifier (1GHz - 26GHz)	EM	EM01M26G	060559	05/21/2020	05/21/2021
Chamber 16	Preamplifier (26GHz - 40GHz)	MITEQ	JS4-26004000-27-5A	818471	05/04/2020	05/04/2021
Chamber 16	Cable (100kHz-1GHz)	HUBER SUHNER	Sucoflex 104A	1166 cable 001	12/25/2020	12/25/2021
Chamber 16	Cable (9kHz-18GHz)	Huber Suhner & Scube	Sucoflex 104A & CA3601-3601-L & CA3601-3601-L	50927/4A & 1166-1G-26G-01 & 1166-1G-26G-02	12/25/2020	12/25/2021
Chamber 16	Cable (18GHz-40GHz)	HUBER SUHNER	Sucoflex 102	27963/2&37421/2	11/19/2020	11/19/2021
Chamber 16	Signal Generator	Anritsu	MG3692A	20311	01/03/2021	01/03/2022
Chamber 16	Test Software	Audix	E3 Ver:6.12023	N/A	N/A	N/A

Location Conducted	Equipment Name	Brand	Model	S/N	Last Cal. Date	Next Cal. Date
Conducted	Power Meter	Anritsu	ML2495A	1116010	09/25/2020	09/25/2021
Conducted	Power Sensor	Anritsu	MA2411B	34NKF50	09/25/2020	09/25/2021
Conducted	Power Sensor	DARE	RPR3006W	13I00030SNO33	01/04/2021	01/04/2022
Conducted	Power Sensor	DARE	RPR3006W	13I00030SNO34	01/04/2021	01/04/2022
Conducted	Power Sensor	DARE	RPR3006W	14I00889SNO35	06/29/2020	06/29/2021
Conducted	Power Sensor	DARE	RPR3006W	14I00889SNO36	06/29/2020	06/29/2021
Conducted	Temperature Chamber	KSON	THS-B4H100	2287	03/11/2020	03/11/2021
Conducted	DC Power supply	ABM	8185D	N/A	01/05/2021	01/05/2022
Conducted	AC Power supply	EXTECH	CFC105W	NA	N/A	N/A
Conducted	Spectrum analyzer	Keysight	N9010A	MY56070257	09/23/2020	09/23/2021
Conducted	Test Software	DARE	Radiation Ver:2013.1.23	NA	NA	NA
Conducted	Test Software	R&S	CMUGO Ver:2.0.0	N/A	N/A	N/A
Conducted	Universal Digital Radio Communication Tester	R&S	CMU200	111968	11/29/2020	11/29/2021
Conducted	Wideband Radio Communication Tester	R&S	CMW500	1201.002K501087 93-JG	10/28/2020	10/28/2021
Conducted	BT Simulator	Agilent	N4010A	MY48100200	NA	NA
Conducted	GPS Simulator	Welnavigate	GS-50	701523	NA	NA
Conducted (TS8997)	Wideband Radio Communication Tester	R&S	CMW500	168811	07/19/2020	07/19/2021
Conducted (TS8997)	Signal Generator	R&S	SMB100B	101085	10/28/2020	10/28/2021
Conducted (TS8997)	Vector Signal Generator	R&S	SMBV100A	263246	10/28/2020	10/28/2021
Conducted (TS8997)	Signal analyzer 40GHz	R&S	FSV40	101884	10/20/2020	10/20/2021
Conducted (TS8997)	OSP150 extension unit CAM-BUS	R&S	OSP150	101107	04/06/2020	04/06/2021
Conducted (TS8997)	Test Software	R&S	EMC32	NA	NA	NA

## **6. RF Output Power**

### **6.1. Limit**

For adaptive equipment using wide band modulations other than FHSS, the maximum RF output power shall be 20 dBm.

The maximum RF output power for non-adaptive equipment shall be declared by the supplier and shall not exceed 20 dBm. See clause 5.3.1 m). For non-adaptive equipment using wide band modulations other than FHSS, the maximum RF output power shall be equal to or less than the value declared by the supplier.

This limit shall apply for any combination of power level and intended antenna assembly.

### **6.2. Test Procedure**

See Sub-Clause 5.4.2.1 of ETSI EN 300 328 for the test conditions

See Sub-Clause 5.4.2.2 of ETSI EN 300 328 for the test method

### 6.3. Test Result

Example Calculation:

Pburst values (A) = Reading + Cable Loss

RF output power (P) = A+G+Y

Ambient temperature: 25°C

Relative humidity: 60%

Test Date: 2020/12/07

**Test Mode: BT LE**

Pburst values (value "A" in dBm)

antenna assembly gain "G" in dBi

0.87 dBi

beamforming gain "Y" in dB

0.00 dB

Cable Loss=

21.00 dB

TEST CONDITIONS	TRANSMITTER POWER (dBm)		
	Lowest Frequency	Middle Frequency	Highest Frequency
Temp -40 °C	P 14.47 dBm	P 16.17 dBm	P 15.57 dBm
	A 13.60 dBm	A 15.30 dBm	A 14.70 dBm
	Reading -7.40 dBm	Reading -5.70 dBm	Reading -6.30 dBm
Temp 25 °C	P 6.67 dBm	P 8.37 dBm	P 7.77 dBm
	A 5.80 dBm	A 7.50 dBm	A 6.90 dBm
	Reading -15.20 dBm	Reading -13.50 dBm	Reading -14.10 dBm
Temp 85 °C	P 6.67 dBm	P 8.27 dBm	P 7.87 dBm
	A 5.80 dBm	A 7.40 dBm	A 7.00 dBm
	Reading -15.20 dBm	Reading -13.60 dBm	Reading -14.00 dBm
Limit(P)	20dBm		
Measurement uncertainty	+ 0.28dB / - 0.30dB		



## 7. Transmitter Unwanted Emissions in the Spurious Domain

### 7.1 Limit

This requirement applies to all types of equipment using wide band modulations other than FHSS.

The transmitter unwanted emissions in the spurious domain shall not exceed the values given in table 2.

In case of equipment with antenna connectors, these limits apply to emissions at the antenna port (conducted). For emissions radiated by the cabinet or emissions radiated by integral antenna equipment (without antenna connectors), these limits are e.r.p. for emissions up to 1 GHz and e.i.r.p. for emissions above 1 GHz.

**Table 2: Transmitter limits for spurious emissions**

Frequency range	Maximum power	Bandwidth
30 MHz to 47 MHz	-36 dBm	100 kHz
47 MHz to 74 MHz	-54 dBm	100 kHz
74 MHz to 87.5 MHz	-36 dBm	100 kHz
87.5 MHz to 118 MHz	-54 dBm	100 kHz
118 MHz to 174 MHz	-36 dBm	100 kHz
174 MHz to 230 MHz	-54 dBm	100 kHz
230 MHz to 470 MHz	-36 dBm	100 kHz
470 MHz to 694 MHz	-54 dBm	100 kHz
694 MHz to 1 GHz	-36 dBm	100 kHz
1 GHz to 12.75 GHz	-30 dBm	1 MHz

### 7.2 Test Procedure

See Sub-Clause 5.4.9.1 of ETSI EN 300 328 for the test conditions

See Sub-Clause 5.4.9.2 and 5.4.9.2.2 of ETSI EN 300 328 for Conducted Pre-Scan test method.

See Sub-Clause 5.4.9.2.2 of ETSI EN 300 328 for final Radiated test method.

### 7.3 Test Result

Model: BT840X

Test Mode: BLE mode, TX CH Low

Ambient temperature: 25°C

Relative humidity: 60%

Test Date: 2020/12/07

No	Freq MHz	Reading dBm	Aux dB	Level dBm	Limit dBm	Margin dB	Pol V/H
1	84.32	-53.14	1.00	-52.14	-36.00	-16.14	VERTICAL
2	191.99	-63.83	2.23	-61.60	-54.00	-7.60	VERTICAL
3	504.33	-74.50	8.95	-65.55	-54.00	-11.55	VERTICAL
4	614.91	-75.28	10.73	-64.55	-54.00	-10.55	VERTICAL
5	742.95	-79.01	13.73	-65.28	-36.00	-29.28	VERTICAL
6	813.76	-75.68	13.83	-61.85	-36.00	-25.85	VERTICAL
7	1553.00	-64.00	2.18	-61.82	-30.00	-31.82	VERTICAL
8	4804.00	-72.98	15.71	-57.27	-30.00	-27.27	VERTICAL
1	84.32	-53.47	0.37	-53.10	-36.00	-17.10	HORIZONTAL
2	191.99	-58.51	1.70	-56.81	-54.00	-2.81	HORIZONTAL
3	594.54	-75.46	11.10	-64.36	-54.00	-10.36	HORIZONTAL
4	665.35	-76.71	11.93	-64.78	-54.00	-10.78	HORIZONTAL
5	740.04	-77.17	13.94	-63.23	-36.00	-27.23	HORIZONTAL
6	813.76	-77.41	14.39	-63.02	-36.00	-27.02	HORIZONTAL
7	1441.00	-63.79	2.16	-61.63	-30.00	-31.63	HORIZONTAL
8	4804.00	-73.89	15.63	-58.26	-30.00	-28.26	HORIZONTAL

Measurement uncertainty	30MHz - 80MHz: 5.04dB
	80MHz -1000MHz: 3.76dB
	1GHz - 26GHz: 4.45dB

Remark:

1. The emission behaviors belong to narrowband spurious emission.
2. Remark " --- " means that the emission level is too low to be measured
3. Aux: Field strength to EIRP correction factor
4. Level (dBm) = Reading (dBm) + Aux (dB)
5. Measurement Range upto 12.75GHz.

**Test Mode: BLE mode, TX CH High**

**Ambient temperature: 25°C**

**Relative humidity: 60%**

**Test Date: 2020/12/07**

No	Freq MHz	Reading dBm	Aux dB	Level dBm	Limit dBm	Margin dB	Pol V/H
1	84.32	-48.82	1.00	-47.82	-36.00	-11.82	VERTICAL
2	191.99	-62.96	2.23	-60.73	-54.00	-6.73	VERTICAL
3	480.08	-72.63	8.99	-63.64	-54.00	-9.64	VERTICAL
4	591.63	-73.03	9.94	-63.09	-54.00	-9.09	VERTICAL
5	741.01	-79.94	13.74	-66.20	-36.00	-30.20	VERTICAL
6	813.76	-75.66	13.83	-61.83	-36.00	-25.83	VERTICAL
7	1994.00	-62.97	4.60	-58.37	-30.00	-28.37	VERTICAL
8	4960.00	-72.95	16.40	-56.55	-30.00	-26.55	VERTICAL
1	84.32	-50.82	0.37	-50.45	-36.00	-14.45	HORIZONTAL
2	191.99	-57.59	1.70	-55.89	-54.00	-1.89	HORIZONTAL
3	594.54	-78.33	11.10	-67.23	-54.00	-13.23	HORIZONTAL
4	665.35	-78.47	11.93	-66.54	-54.00	-12.54	HORIZONTAL
5	742.95	-79.10	14.04	-65.06	-36.00	-29.06	HORIZONTAL
6	816.67	-76.84	14.44	-62.40	-36.00	-26.40	HORIZONTAL
7	1994.00	-63.65	4.75	-58.90	-30.00	-28.90	HORIZONTAL
8	4960.00	-72.92	16.15	-56.77	-30.00	-26.77	HORIZONTAL

Measurement uncertainty	30MHz - 80MHz: 5.04dB
	80MHz - 1000MHz: 3.76dB
	1GHz - 26GHz: 4.45dB

**Remark:**

1. The emission behaviors belong to narrowband spurious emission.
2. Remark " --- " means that the emission level is too low to be measured
3. Aux: Field strength to EIRP correction factor
4. Level (dBm) = Reading (dBm) + Aux (dB)
5. Measurement Range upto 12.75GHz.

## 8. Receiver Blocking

### 8.1 Receiver Blocking

This requirement applies to all receiver categories below.

#### Receiver categories

##### Receiver category 1

Adaptive equipment with a maximum RF output power greater than 10 dBm e.i.r.p. shall be considered as receiver category 1 equipment.

##### Receiver category 2

Non-adaptive equipment with a Medium Utilization (MU) factor greater than 1 % and less than or equal to 10 % or adaptive equipment with a maximum RF output power of 10 dBm e.i.r.p. shall be considered as receiver category 2 equipment.

##### Receiver category 3

Non-adaptive equipment with a maximum Medium Utilization (MU) factor of 1 % or adaptive equipment with a maximum RF output power of 0 dBm e.i.r.p. shall be considered as receiver category 3 equipment.

### 8.2 Limit

While maintaining the minimum performance criteria as defined in clause 4.3.2.11.3, the blocking levels at specified frequency offsets shall be equal to or greater than the limits defined for the applicable receiver category provided table 3, table 4 or table 5.

**Table 3: Receiver Blocking parameters receiver category 1 equipment**

Wanted signal mean power from companion device (dBm) (see notes 1 and 4)	Blocking signal frequency (MHz)	Blocking signal power (dBm) (see note 4)	Type of blocking signal
(-133 dBm + 10 × log <sub>10</sub> (OCBW)) or -68 dBm whichever is less (see note 2)	2380	-34	CW
	2504		
(-139 dBm + 10 × log <sub>10</sub> (OCBW)) or -74 dBm whichever is less (see note 3)	2300		
	2330		
	2360		
	2524		
	2584		
NOTE 1: OCBW is in Hz.			
NOTE 2: In case of radiated measurements using a companion device and the level of the wanted signal from the companion device cannot be determined, a relative test may be performed using a wanted signal up to P <sub>min</sub> + 26 dB where P <sub>min</sub> is the minimum level of wanted signal required to meet the minimum performance criteria as defined in clause 4.3.1.12.3 in the absence of any blocking signal.			
NOTE 3: In case of radiated measurements using a companion device and the level of the wanted signal from the companion device cannot be determined, a relative test may be performed using a wanted signal up to P <sub>min</sub> + 20 dB where P <sub>min</sub> is the minimum level of wanted signal required to meet the minimum performance criteria as defined in clause 4.3.1.12.3 in the absence of any blocking signal.			
NOTE 4: The level specified is the level at the UUT receiver input assuming a 0 dBi antenna assembly gain. In case of conducted measurements, this level has to be corrected for the (in-band) antenna assembly gain (G). In case of radiated measurements, this level is equivalent to a power flux density (PFD) in front of the UUT antenna with the UUT being configured/positioned as recorded in clause 5.4.3.2.2.			

**Table 4: Receiver Blocking parameters receiver category 2 equipment**

Wanted signal mean power from companion device (dBm) (see notes 1 and 3)	Blocking signal frequency (MHz)	Blocking signal power (dBm) (see note 3)	Type of blocking signal
$(-139 \text{ dBm} + 10 \times \log_{10}(\text{OCBW}) + 10 \text{ dB})$ or $(-74 \text{ dBm} + 10 \text{ dB})$ whichever is less (see note 2)	2380 2504 2300 2584	-34	CW
<p>NOTE 1: OCBW is in Hz.</p> <p>NOTE 2: In case of radiated measurements using a companion device and the level of the wanted signal from the companion device cannot be determined, a relative test may be performed using a wanted signal up to <math>P_{\text{min}} + 26 \text{ dB}</math> where <math>P_{\text{min}}</math> is the minimum level of wanted signal required to meet the minimum performance criteria as defined in clause 4.3.1.12.3 in the absence of any blocking signal.</p> <p>NOTE 3: The level specified is the level at the UUT receiver input assuming a 0 dBi antenna assembly gain. In case of conducted measurements, this level has to be corrected for the (in-band) antenna assembly gain (G). In case of radiated measurements, this level is equivalent to a power flux density (PFD) in front of the UUT antenna with the UUT being configured/positioned as recorded in clause 5.4.3.2.2.</p>			

**Table 5: Receiver Blocking parameters receiver category 3 equipment**

Wanted signal mean power from companion device (dBm) (see notes 1 and 3)	Blocking signal frequency (MHz)	Blocking signal power (dBm) (see note 3)	Type of blocking signal
$(-139 \text{ dBm} + 10 \times \log_{10}(\text{OCBW}) + 20 \text{ dB})$ or $(-74 \text{ dBm} + 20 \text{ dB})$ whichever is less (see note 2)	2380 2504 2300 2584	-34	CW
<p>NOTE 1: OCBW is in Hz.</p> <p>NOTE 2: In case of radiated measurements using a companion device and the level of the wanted signal from the companion device cannot be determined, a relative the test may be performed using a wanted signal up to <math>P_{\text{min}} + 30 \text{ dB}</math> where <math>P_{\text{min}}</math> is the minimum level of wanted signal required to meet the minimum performance criteria as defined in clause 4.3.1.12.3 in the absence of any blocking signal.</p> <p>NOTE 3: The level specified is the level at the UUT receiver input assuming a 0 dBi antenna assembly gain. In case of conducted measurements, this level has to be corrected for the (in-band) antenna assembly gain (G). In case of radiated measurements, this level is equivalent to a power flux density (PFD) in front of the UUT antenna with the UUT being configured/positioned as recorded in clause 5.4.3.2.2.</p>			

### 8.3 Test Procedure

See Sub-Clause 5.4.11.1 of ETSI EN 300 328 for the test conditions

See Sub-Clause 5.4.11.2 of ETSI EN 300 328 for conducted method.

## 8.4 Test Result

### Receiver Blocking (Lowest Channel)

Definition: Receiver blocking is a measure of the ability of the equipment to receive a wanted signal on its operating channel without exceeding a given degradation in the presence of an unwanted signal (blocking signal) on frequencies other than those of the operating band.

#### Summary

DUT Frequency (MHz)	Receiver Category	Companion RMS burst power (dBm)	Result
2402.000000	1	---	PASS

#### Measurement Overview

Blocking Frequency (MHz)	Result no Offset	Result Offset 1	Result Offset 2	Result
2380.000000	PASS	not tested	not tested	PASS
2300.000000	PASS	not tested	not tested	PASS
2330.000000	PASS	not tested	not tested	PASS
2360.000000	PASS	not tested	not tested	PASS

#### Measurements

#	Blocking Frequency (MHz)	Blocking Frequency Offset (MHz)	Generator Frequency (MHz)	Blocking Level at DUT (dBm)	Generator Level (dBm)	Attenuation Generator to DUT (dB)
1	2380.000000	0.000000	2380.000000	-33.0	-2.6	30.4
2	2380.000000	10.000000	---	---	---	---
3	2380.000000	-10.000000	---	---	---	---
4	2300.000000	0.000000	2300.000000	-33.0	-2.6	30.4
5	2300.000000	20.000000	---	---	---	---
6	2300.000000	-20.000000	---	---	---	---
7	2330.000000	0.000000	2330.000000	-33.0	-2.6	30.4
8	2330.000000	20.000000	---	---	---	---
9	2330.000000	-20.000000	---	---	---	---
10	2360.000000	0.000000	2360.000000	-33.0	-2.6	30.4
11	2360.000000	20.000000	---	---	---	---
12	2360.000000	-20.000000	---	---	---	---

(continuation of the "Measurements" table from column 7 ...)

#	Level of Wanted Signal at DUT (dBm)	Wanted Level Offset (dB)	Attenuation Companion to DUT (dB)	Result
1	-67.0	0.0	30.5	PASS
2	-64.0	3.0	---	not tested
3	-70.0	-3.0	---	not tested
4	-73.0	0.0	30.5	PASS
5	-73.0	0.0	---	not tested
6	-73.0	0.0	---	not tested
7	-73.0	0.0	30.5	PASS
8	-73.0	0.0	---	not tested
9	-73.0	0.0	---	not tested
10	-73.0	0.0	30.5	PASS
11	-73.0	0.0	---	not tested
12	-73.0	0.0	---	not tested

### DUT Monitoring

#	Blocking Frequency (MHz)	Blocking Frequency Offset (MHz)	Name	Value	Limit Min	Limit Max	Result
1	2380.000000	0.000000	WLAN PER	2.000	---	10.000	PASS
2	2300.000000	0.000000	WLAN PER	1.200	---	10.000	PASS
3	2330.000000	0.000000	WLAN PER	0.600	---	10.000	PASS
4	2360.000000	0.000000	WLAN PER	0.800	---	10.000	PASS

## Receiver Blocking (Highest Channel)

Definition: Receiver blocking is a measure of the ability of the equipment to receive a wanted signal on its operating channel without exceeding a given degradation in the presence of an unwanted signal (blocking signal) on frequencies other than those of the operating band.

### Summary

DUT Frequency (MHz)	Receiver Category	Companion RMS burst power (dBm)	Result
2480.0000	1	---	PASS

### Measurement Overview

Blocking Frequency (MHz)	Result no Offset	Result Offset 1	Result Offset 2	Result
2504.000000	PASS	not tested	not tested	PASS
2524.000000	PASS	not tested	not tested	PASS
2584.000000	PASS	not tested	not tested	PASS
2674.000000	PASS	not tested	not tested	PASS

### Measurements

#	Blocking Frequency (MHz)	Blocking Frequency Offset (MHz)	Generator Frequency (MHz)	Blocking Level at DUT (dBm)	Generator Level (dBm)	Attenuation Generator to DUT (dB)
1	2504.000000	0.000000	2504.000000	-34.0	-4.4	29.6
2	2504.000000	10.000000	---	---	---	---
3	2504.000000	-10.000000	---	---	---	---
4	2524.000000	0.000000	2524.000000	-34.0	-4.4	29.6
5	2524.000000	20.000000	---	---	---	---
6	2524.000000	-20.000000	---	---	---	---
7	2584.000000	0.000000	2584.000000	-34.0	-4.3	29.7
8	2584.000000	20.000000	---	---	---	---
9	2584.000000	-20.000000	---	---	---	---
10	2674.000000	0.000000	2674.000000	-34.0	-4.3	29.7
11	2674.000000	20.000000	---	---	---	---
12	2674.000000	-20.000000	---	---	---	---

(continuation of the "Measurements" table from column 7 ...)

#	Level of Wanted Signal at DUT (dBm)	Wanted Level Offset (dB)	Attenuation Companion to DUT (dB)	Result
1	-68.0	0.0	50.1	PASS
2	-71.0	-3.0	---	not tested
3	-65.0	3.0	---	not tested
4	-74.0	0.0	50.1	PASS
5	-74.0	0.0	---	not tested
6	-74.0	0.0	---	not tested
7	-74.0	0.0	50.1	PASS
8	-74.0	0.0	---	not tested
9	-74.0	0.0	---	not tested
10	-74.0	0.0	50.1	PASS
11	-74.0	0.0	---	not tested
12	-74.0	0.0	---	not tested



### DUT Monitoring

#	Blocking Frequency (MHz)	Blocking Frequency Offset (MHz)	Name	Value	Limit Min	Limit Max	Result
1	2504.000000	0.000000	WLAN PER	0.400	---	10.000	PASS
2	2524.000000	0.000000	WLAN PER	0.600	---	10.000	PASS
3	2584.000000	0.000000	WLAN PER	1.000	---	10.000	PASS
4	2674.000000	0.000000	WLAN PER	1.400	---	10.000	PASS

# **APPENDIX 1**

## **PHOTOGRAPHS OF SET UP**

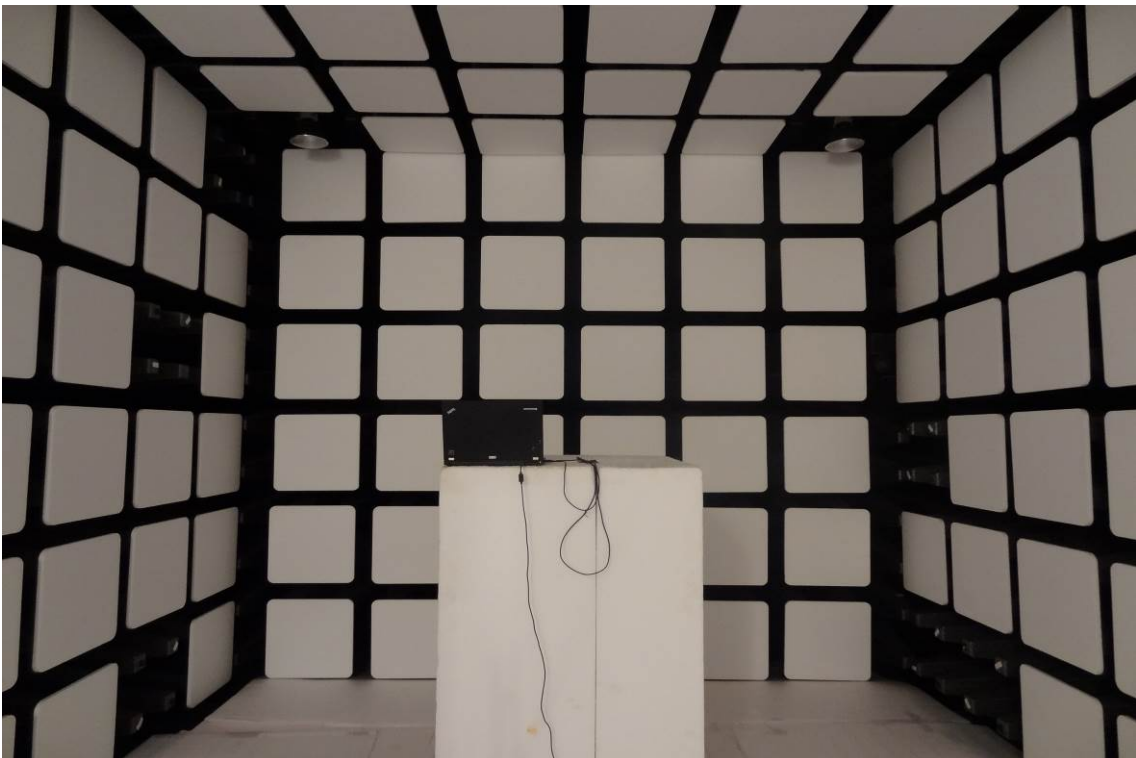
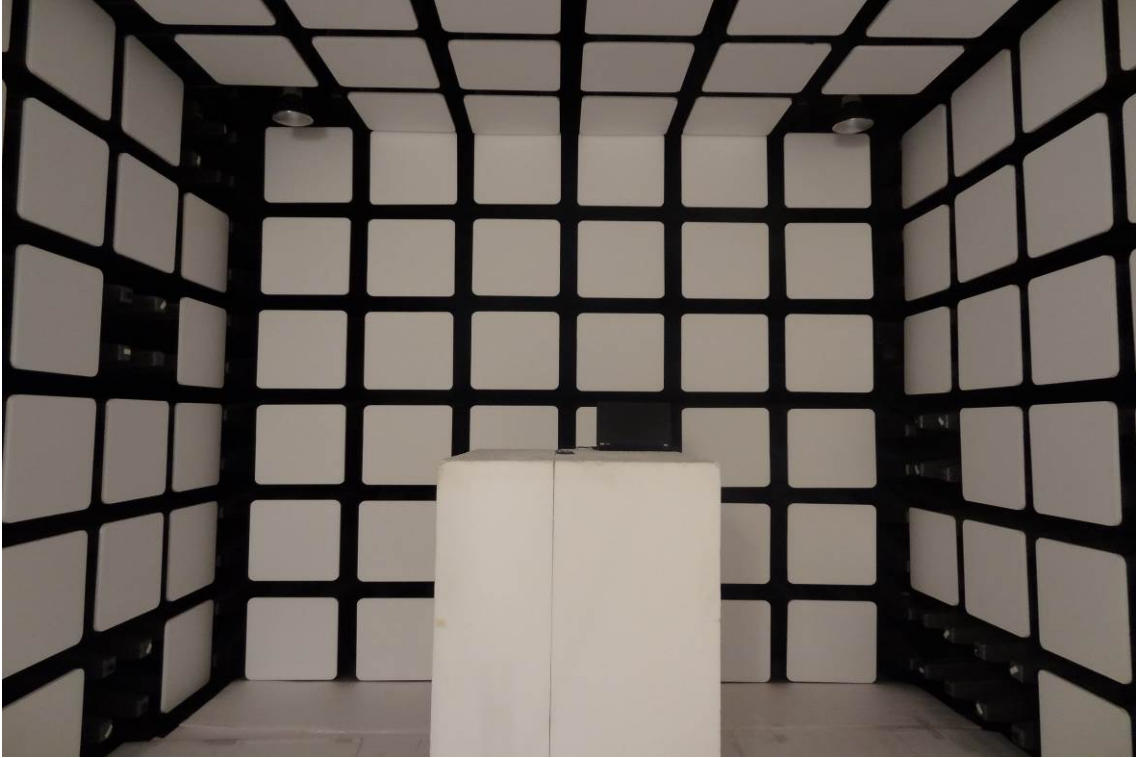



**Receiver Blocking Test Setup**

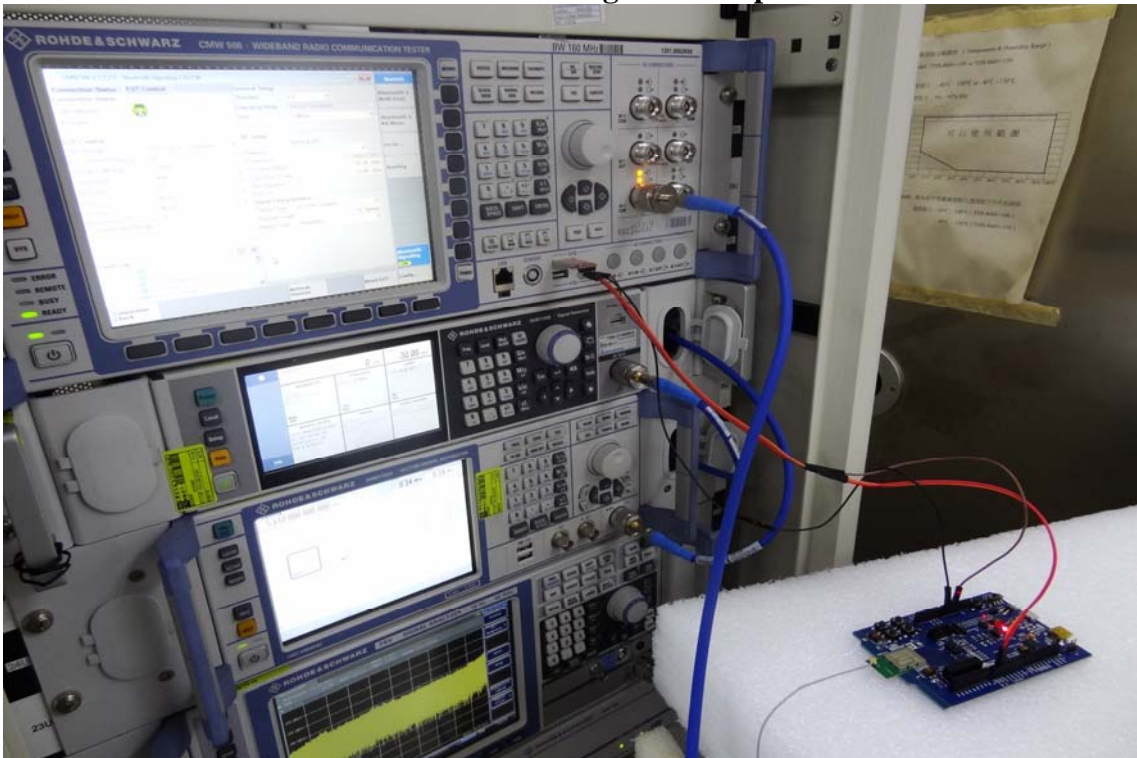

## **APPENDIX 2**

# **PHOTOGRAPHS OF EUT**

**EUT 1**

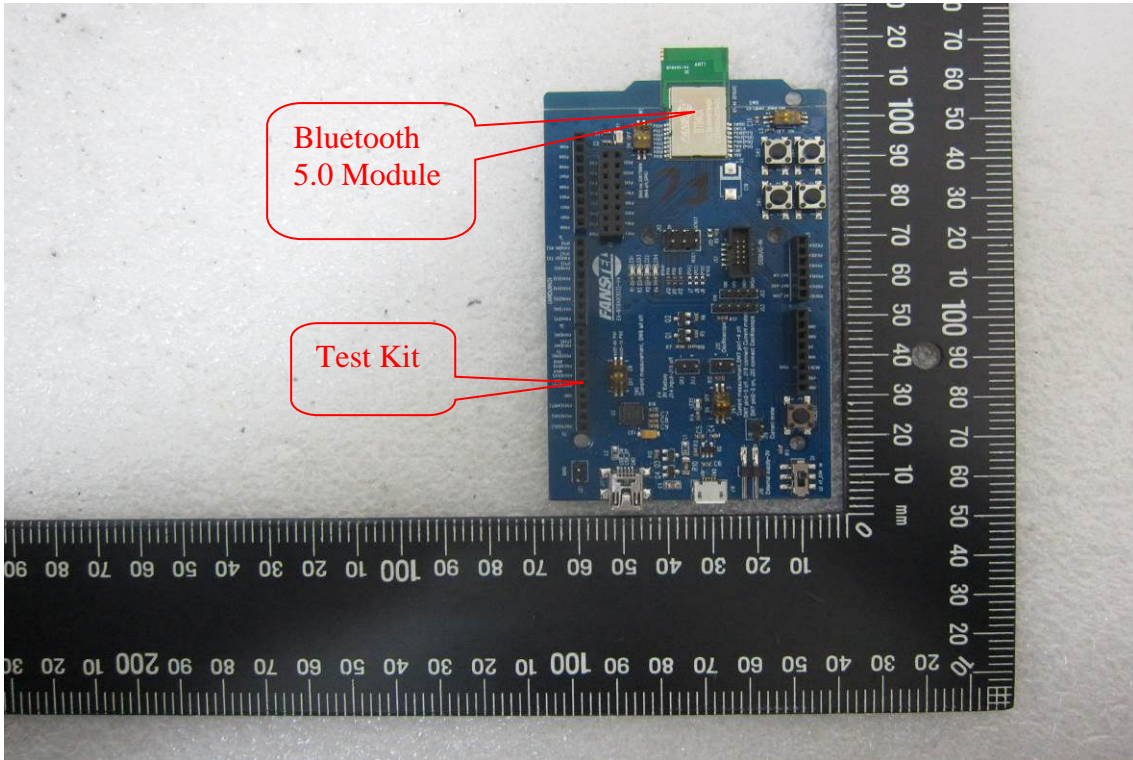

**EUT 2**

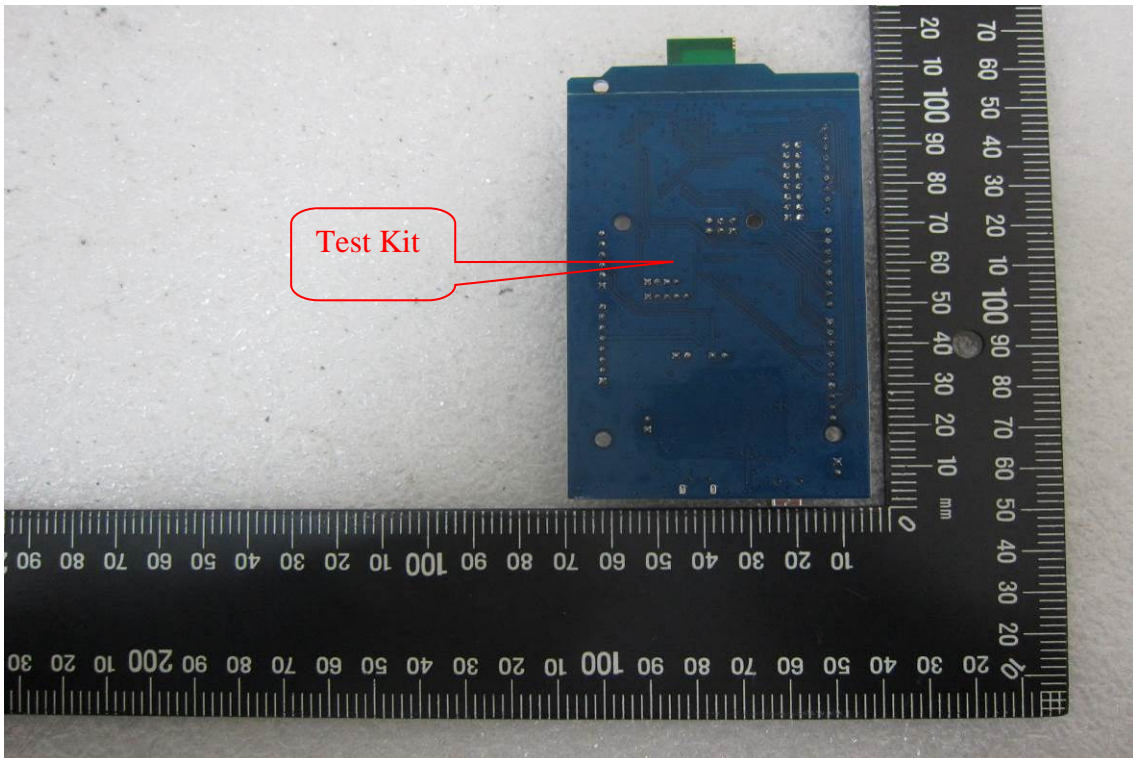

EUT 3 BT840X

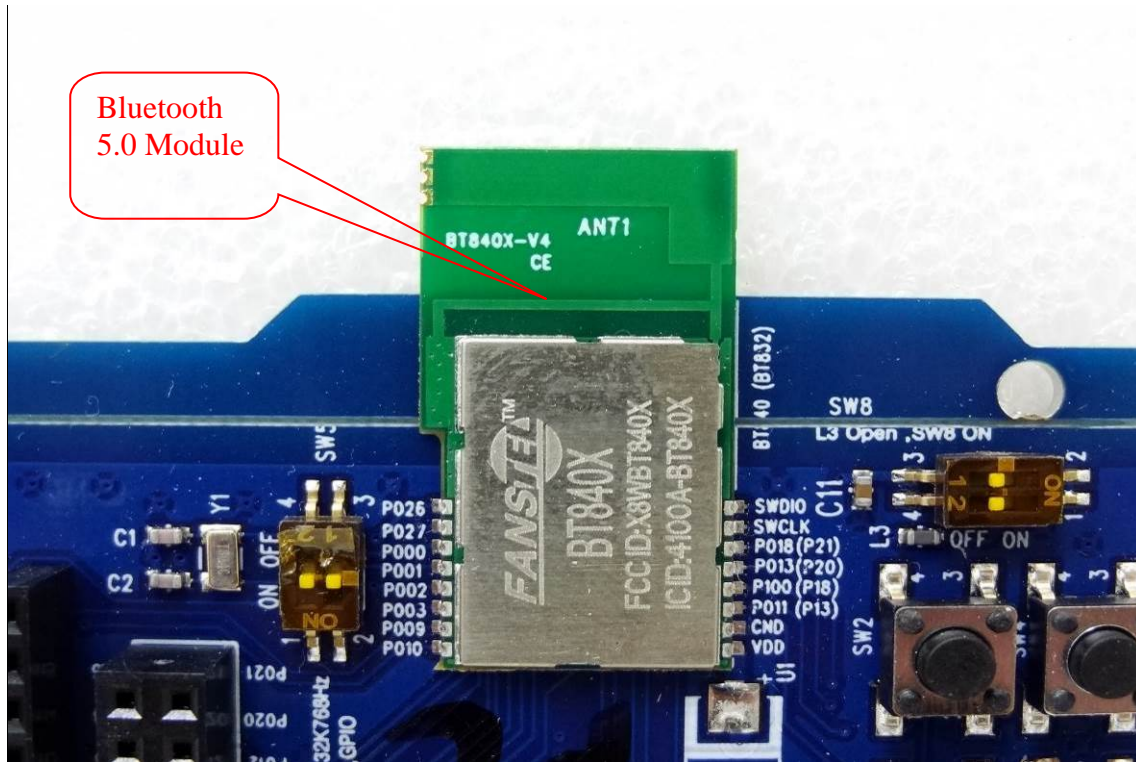

EUT 4 BT840XE

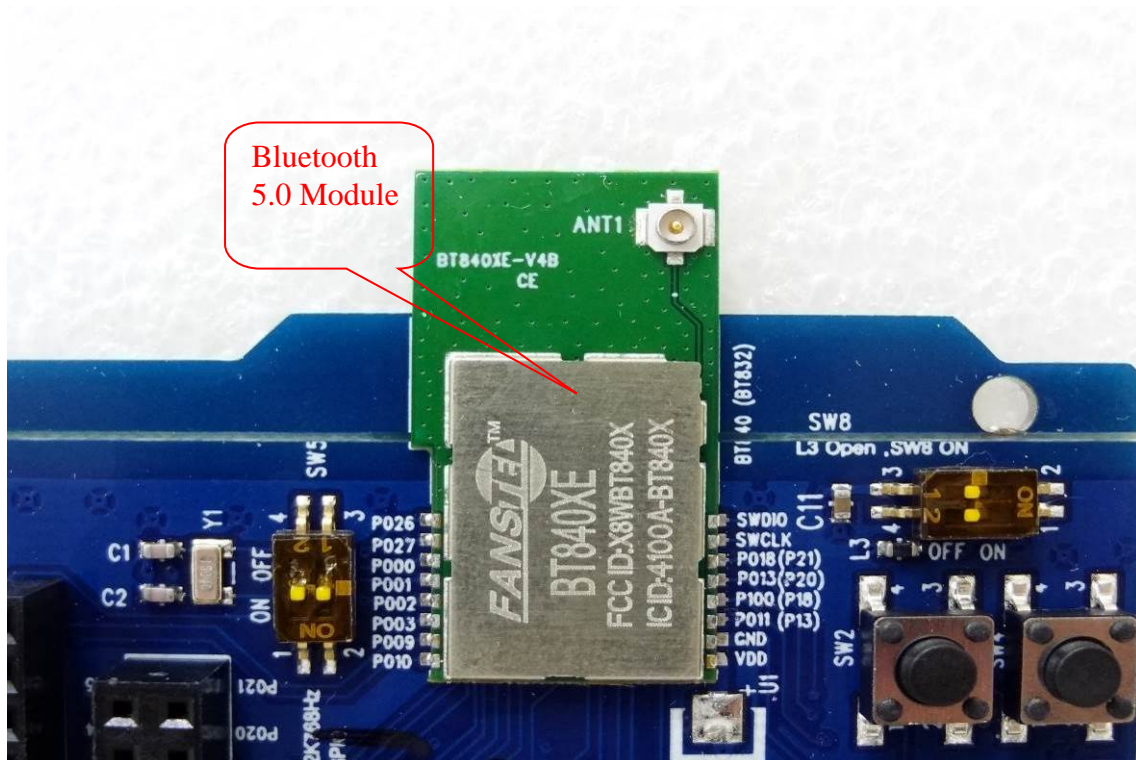

**EUT 5 BT840XE**

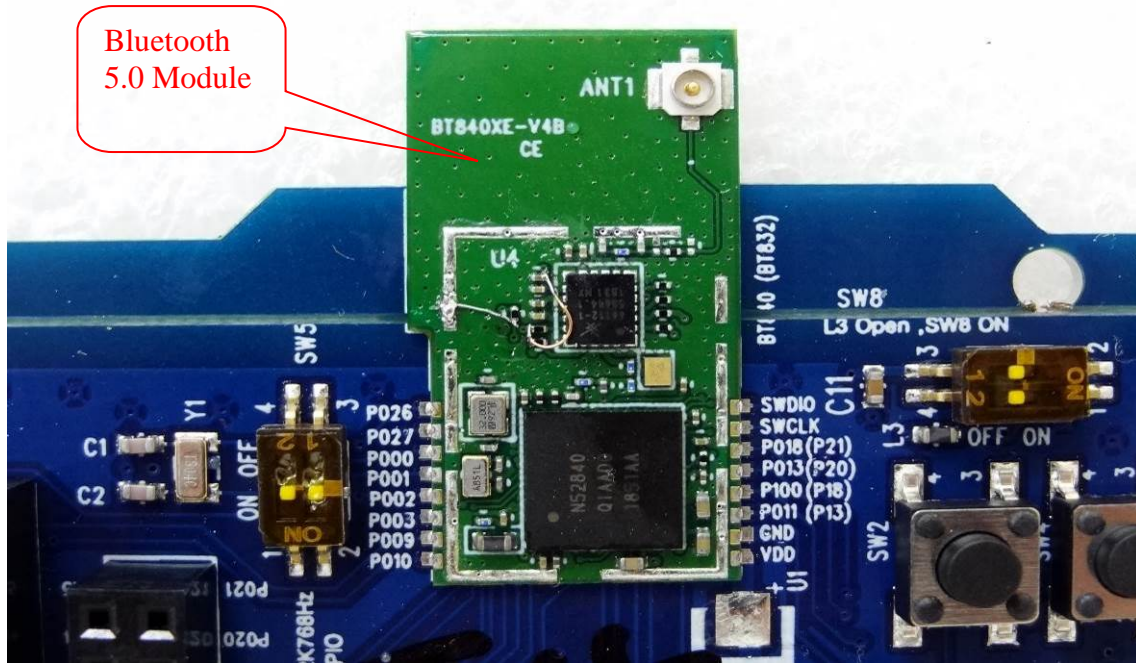

**EUT 6 BT840XE**

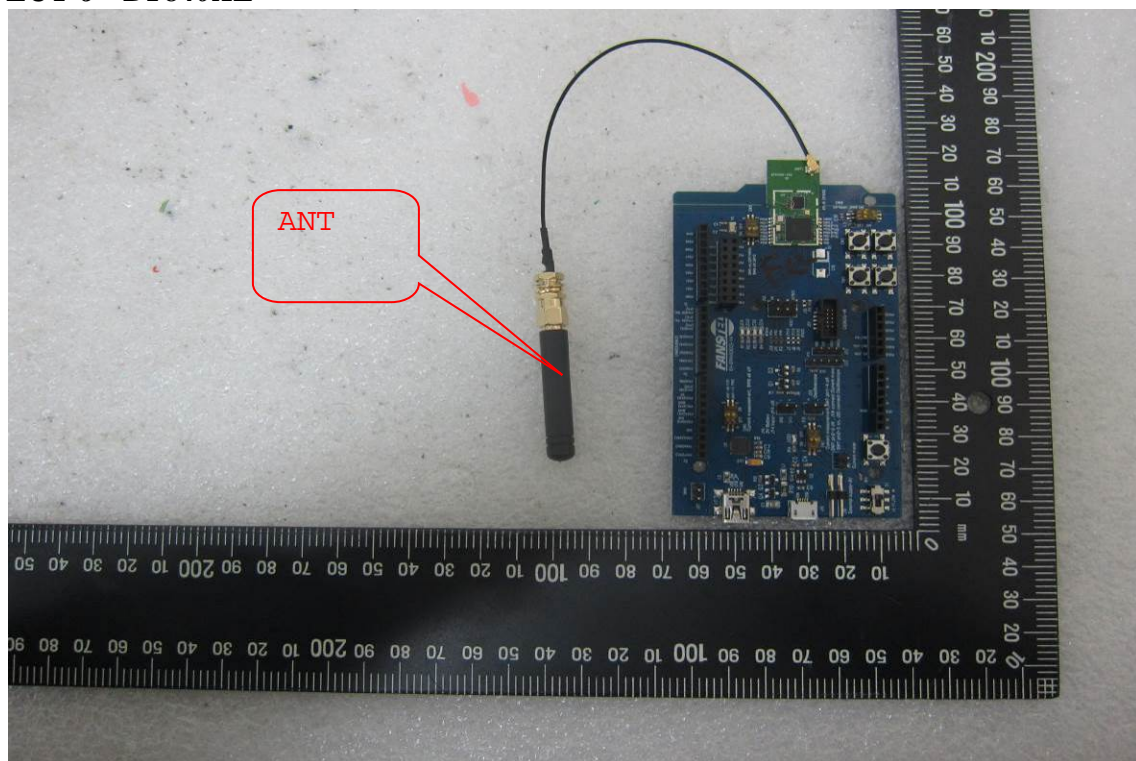



**EUT 7 BT840XE**

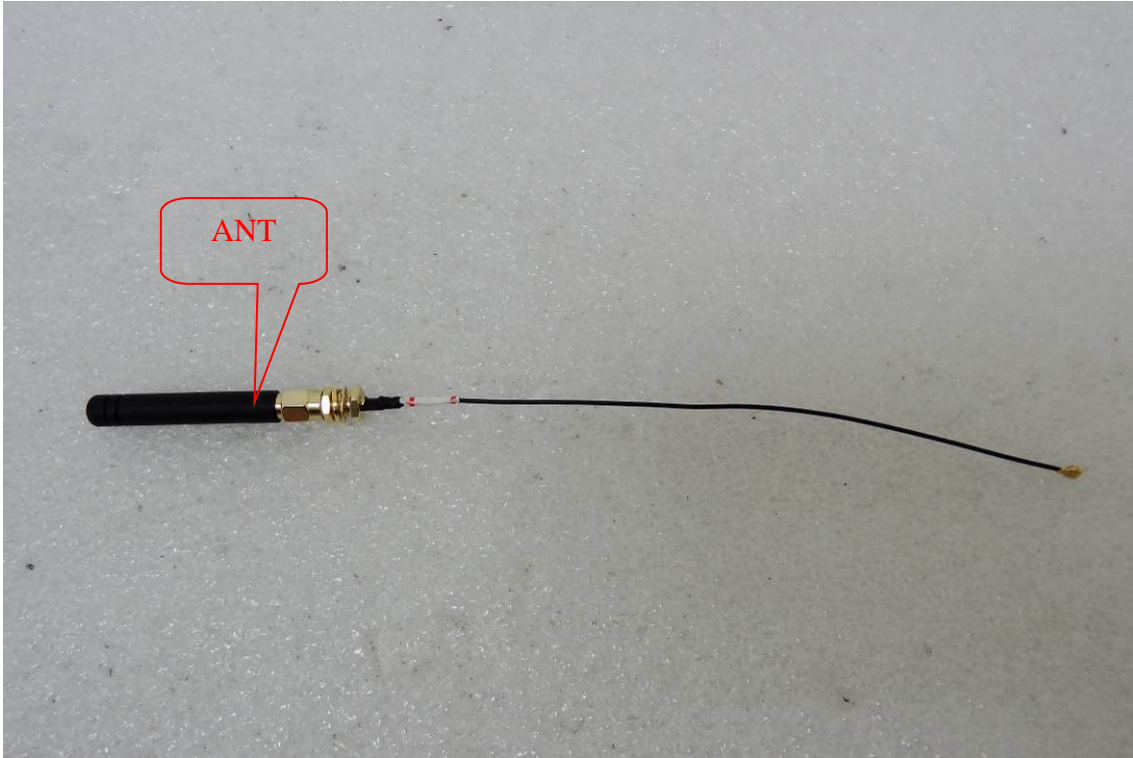

**EUT 8 BT840X**

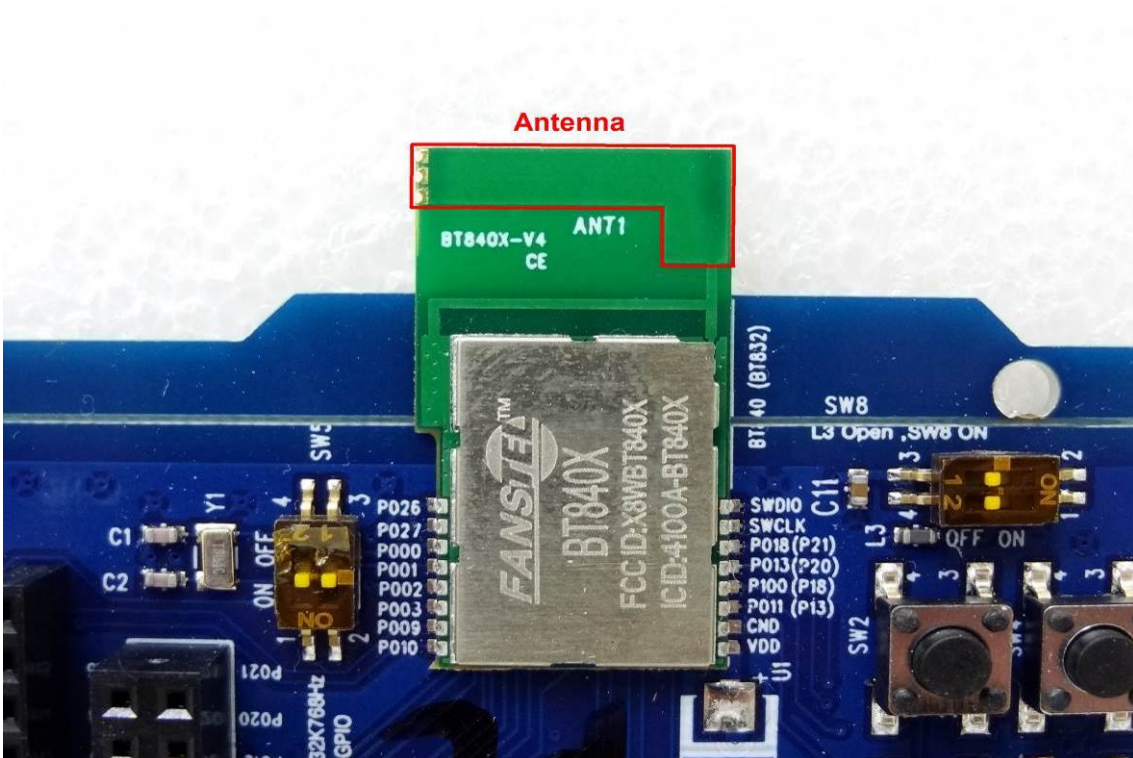

~ End of Report ~