

Compact nRF5340 BLE 5.3, 802.15.4 Modules

Ver 1.01 Nov. 2022

BluNor BC40C is a powerful, highly flexible, ultra low power Bluetooth Low Energy (BLE) module using Nordic nRF5340 SoC. With a dual core ARM Cortex™ M33 MCU, embedded 2.4GHz multi-protocol transceiver, and an integrated PCB trace antenna, a chip antenna, or pads for an external antenna. It allows faster time to market with reduced development cost.

No external component needed to minimize host PCB area: Both 32 MHz and 32.768 KHz, -40°C to +105°C, 20 PPM crystals are integrated. DCDC inductors for VDD and VDDH are integrated.

BC40C, BC40M, and BC40P are small in sizes and also short in Bluetooth ranges. If you have applications needing long range, please use [BT40F](#), [BT40E](#) (globally certified with a 6 dBi antenna) or BT40X (with a PA).

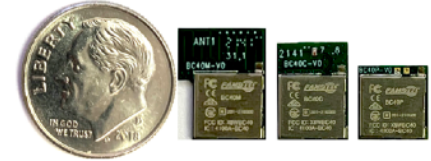

Specifications:

- nRF5340 CLAA, dual core ARM® Cortex M33
- Application Core
 - 128/64 MHz Cortex M33 with FPU and DSP instructions
 - 1MB flash, 512KB RAM
 - 8KB 2-way set associate cache
 - ARM® TrustZone® Cryptocell-312 co-processor
- Network core:
 - 64 MHz Cortex M33 with 2KB instruction cache
 - 256KB flash, 64KB RAM
 - 2.6 mA in RX and 3.2 mA in 0dBm TX
 - Receiver Sensitivity: -98 dBm at 1Mbps
 - TX power: programmable +3dBm to -20dBm
 - BLE 5.1 data rate: 2Mbps, 1Mbps, 500kbps, 125kbps.
 - IEEE 802.15.4 data rate: 250 Kbps
 - 2.4 GHz proprietary data rate: 2 Mbps, 1 Mbps
- DC-DC converter, inductors for VDD, VDDH on board.
- Direct powered by Lithium batteries or USB supply (up to 5.5V)
- Serial Wire Debug (SWD)
- Nordic SoftDevice Ready
- Over-the-Air (OTA) firmware update
- 48 General purpose I/O pins
- USB 2.0 full speed (12 Mbps) controller
- QSPI interface
- Type 2 NFC-A tag with wake-on field, Touch-to-pair support
- Programmable peripheral interconnect (PPI)
- 12 bit/200 Ksps ADC, 8 configurable channels with programmable gain
- Temperature sensor
- Up to 3x pulse width modulator (PWM)
- Audio peripherals: I²S, digital microphone interface (PDM)
- 5 x 32 bit timers with counter mode
- Up to 3x SPI masters/3x SPI slaves
- Up to 2x I²C compatible 2-wire masters/slaves
- 2x UART (CTS/RTS)
- Quadrature Demodulator (QDEC)
- 2x real time counters (RTC)
- LGA pins: 64.
- Both 32 MHz and 32.768KHz crystals on board
- Integrated PCB trace or chip antenna
- Operation voltage: 1.7V to 5.5V
- FCC ID: X8WBC40
- ISED ID: 4100A-BC40
- TELEC ID: 201-210509/01
- CE, RCM: Compliant
- QDID:119517
- All modules support **approtect** features.

Model Summaries

module	BC40C	BC40M	BC40P
SoC	nRF5340 CLAA	nRF5340 CLAA	nRF5340 CLAA
Size	8.4x11.5x1.6 mm	8.4(10.1)x12.7x1.6mm	8.4x9.0x1.6mm
32 MHz and 32.768 kHz crystals	Integrated	Integrated	Integrated
DC converter inductors, VDD, VDDH	Integrated	Integrated	Integrated
BT Antenna	Chip	PCB trace	Pads for external
Max TX	+3.60 dBm	+3.60 dBm	+3.60 dBm
Bluetooth range, estimated	50 meters	100 meters	200 meters
Operating temp.	-40°C to +105°C	-40°C to +105°C	-40°C to +105°C
Availability	Production	Production	Production

Table Of Contents

1. Introduction.....	3
BC40C Block Diagram.....	3
2. Codes Development Using Nordic Tools.....	5
Over-The-Air DFU	5
nRF Connect SDK.....	5
Development Tools	5
3. Product Descriptions	6
Block Diagram of nRF5340	6
Mechanical Drawings	8
Pin Assignments of BC40C.....	11
Pin Function.....	12
Using Internal Load Capacitors for the High Frequency Oscillator.....	14
Mounting BC40M and BC40C on the Host PCB	16
Host Board Design for Low Cost or Long Range	17
4. BC40C Evaluation Board	18
EV-BC40C and EV-BC40M Evaluation Board Schematics	19
EV-BC40P Evaluation Board Schematics	20
Nordic Development Tools.....	21
Android OS Apps	21
iOS Apps.....	21
EV-BC40C EvaluationBoard Schematics	22
Suggestion for Battery Power Application	22
5. Miscellaneous.....	23
Soldering Temperature-Time Profile for Re-Flow Soldering	23
Cautions, Design Notes, and Installation Notes	23
Packaging and Lot Number	27
FCC Label	27
Revision History	28
Contact Us	29

1. Introduction

BluNor BC40C Series are powerful, highly flexible, ultra low power wireless modules using Nordic nRF5340 SoCs. With a dual core ARM Cortex™ M33 MCU, embedded 2.4GHz multi-protocol transceiver, and an integrated antenna, it allows faster time to market with reduced development cost.

BC40C Block Diagram

The following is a block diagram of BC40C. Antenna circuit and main clock are integrated. All 48 GPIOs of nRF5340 can be accessed from main board. For lower power consumption at idle state, a 32.768 kHz crystal can be added on the host board. Connection to an external NFC (Near Field Communication) antenna is provided.

There are 3 modules in the BC40C Series.

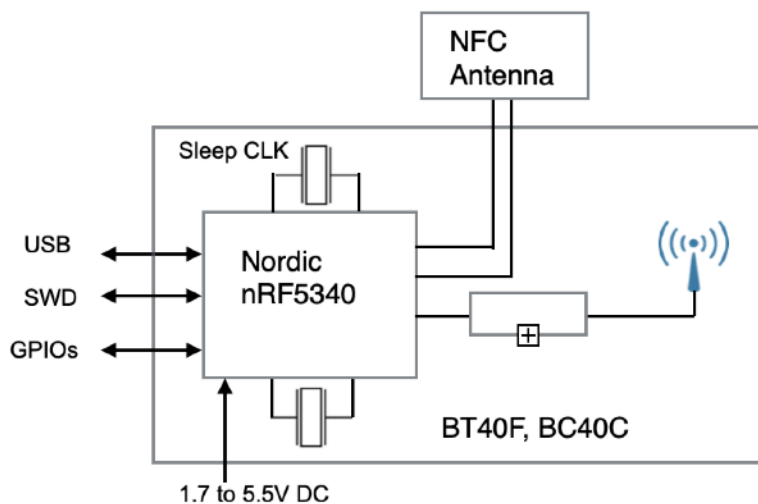

BC40C

- Uses an nRF5340 CLAA with dual core Cortex M33 MCU
- Application core: 128MHz Cortex M33, 1MB flash/512KB RAM.
- Network core: 64MHz Cortex M33, 256KB flash/64KB RAM.
- 32 MHz and 32.768 KHz crystals embedded.
- DCDC converter inductors/capacitor for VDD and VDDH embedded.
- Integrated chip antenna.
- Size: 8.4x11.5x1.6mm



BC40M

- Uses an nRF5340 CLAA with dual core Cortex M33 MCU
- Application core: 128MHz Cortex M33, 1MB flash/512KB RAM.
- Network core: 64MHz Cortex M33, 256KB flash/64KB RAM.
- 32 MHz and 32.768 KHz crystals embedded.
- DCDC converter inductors/capacitor for VDD and VDDH embedded.
- Integrated PCB trace antenna.
- Size: 8.4 (10.1)x12.7x1.6mm, L shape.



Compact nRF5340 BLE 5.3, 802.15.4 Modules

Ver 1.01 Nov. 2022

BC40P

- Uses an nRF5340 CLAA with dual core Cortex M33 MCU
- Application core: 128MHz Cortex M33, 1MB flash/512KB RAM.
- Network core: 64MHz Cortex M33, 256KB flash/64KB RAM.
- 32 MHz and 32.768 KHz crystals embedded.
- DCDC converter inductors/capacitor for VDD and VDDH embedded.
- Pads for an external antenna. FCC certified with ANT020 antenna.
- Size: 8.4x9.0x1.6mm.



2. Codes Development Using Nordic Tools

Development tools from Nordic and other third party development tools recommended by Nordic should be used.

Over-The-Air DFU

The nRF5340 is supported by an Over-The-Air Device Firmware Upgrade (OTA DFU) feature. This allows for in the field updates of application software and SoftDevice.

nRF Connect SDK

nRF Connect SDK is a scalable and unified software development kit for building products based on all our nRF52, nRF53 and nRF91 Series wireless devices. It offers developers an extensible framework for building size-optimized software for memory-constrained devices as well as powerful and complex software for more advanced devices and applications. It integrates the Zephyr RTOS and a wide range of samples, application protocols, protocol stacks, libraries and hardware drivers.

For developing Bluetooth Low Energy, Thread and Zigbee products, the nRF Connect SDK contains all needed software, including protocol stacks. For developing cellular IoT products it contains everything except the LTE modem firmware that must be downloaded separately from the [nRF9160 SiP product page](#). See the [cellular IoT software](#) for more details.

nRF Connect SDK also offers an unique integration of HomeKit Accessory Development Kit for developing products using both HomeKit over Thread and HomeKit over Bluetooth Low Energy. It is a highly optimized solution that enables battery-powered products with both the HomeKit Accessory Protocol (HAP) and application firmware running on a single chip. MFi licensees can get access to the HomeKit repository by contacting us via [Nordic DevZone private ticket](#).

nRF Connect SDK offers a single code base for all our devices and software components. It simplifies porting modules, libraries and drivers from one application to another, thus reducing development time. By enabling developers to pick and choose the essential software components for their application, high memory efficiency is guaranteed.

nRF Connect SDK is publicly hosted on GitHub, offers source code management with Git and has free SEGGER Embedded Studio IDE support. Nordic runs continuous integration tests on the nRF Connect SDK code to ensure robust and secure production quality code.

Development Tools

Nordic Semiconductor provides a complete range of hardware and software development tools for the nRF53 Series devices. nRF53 DK board is recommended for firmware development.

[Nordic software development tools](#) can be downloaded.

3. Product Descriptions

Brief description of nRF5340 SoC is provided. For full description of the SoC, please download from Nordic Semiconductor website.

<https://www.nordicsemi.com/eng/Products/Bluetooth-low-energy>

Block Diagram of nRF5340

The following is a block diagram of Nordic nRF5340 Bluetooth Low Energy (BLE) SoC. Arrows with white heads indicate signals that share physical pins with other signals.

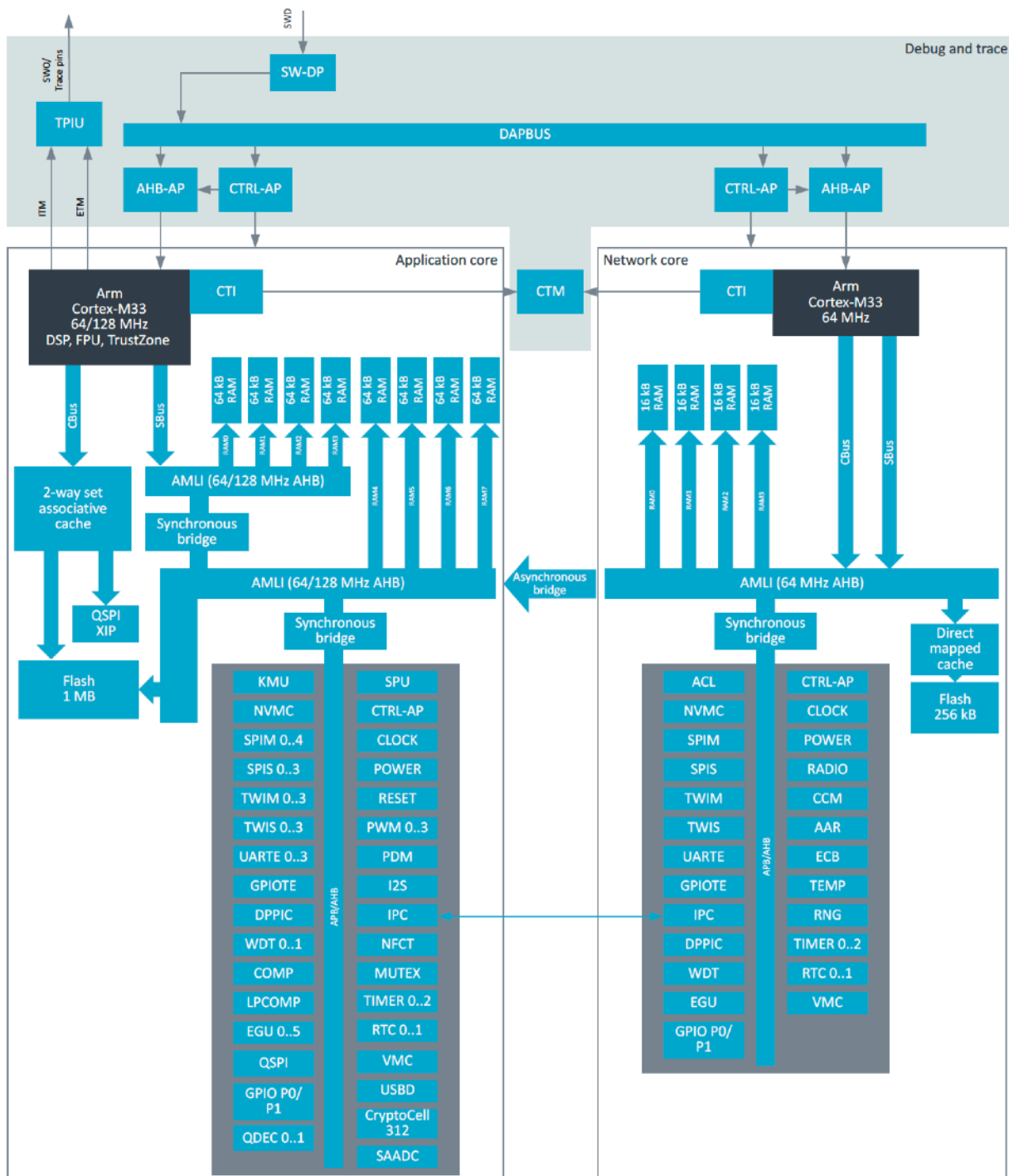

Compact nRF5340 BLE 5.3, 802.15.4 Modules

Ver 1.01 Nov. 2022

nRF5340 is a wireless ultra-low power multiple core System on Chip (SoC) integrating two fully programmable Arm Cortex M33 processors, advanced security features, a range of peripherals, and a multi protocol 2.4 GHz transceiver. The transceiver supports Bluetooth low energy, ANT™, and 802.15.4 and allows the implementation of proprietary 2.4 GHz protocols.

The two Arm Cortex M33 processors share the power, clock, and peripheral architecture with Nordic Semiconductor nRF51, nRF52, and nRF91 Series of PAN/LAN SoCs, ensuring minimal porting efforts. The application core is a full-featured Arm Cortex M33 processor including DSP instructions and FPU and running at up to 128 MHz with 1MB of flash and 512 KB of RAM. The option to run the application processor at 64 MHz allows the CPU to increase energy efficiency. The network core is an Arm Cortex M33 processor with a reduced feature set, designed for ultra-low power operation. It runs at a fixed 64 MHz frequency and contains 256 KB of flash and 64 KB of RAM.

The peripheral set offers a variety of analog and digital functionality enabling single chip implementation of a wide range of applications. Arm trustZone technology, Arm cryptoCell-312, and supporting blocks for system protection and key management are embedded for the advanced security needed for IoT applications.

Compact nRF5340 BLE 5.3, 802.15.4 Modules

Ver 1.01 Nov. 2022

Mechanical Drawings

Soldering pads are identical for BC40C, BC40M, and BC40P. All modules have 64 LGA (Land Grid Array) pins.

Antenna areas are different. Mechanical drawings are different.

BC40C mechanical drawings, top view. Module size is 8.4x11.5x1.6mm.

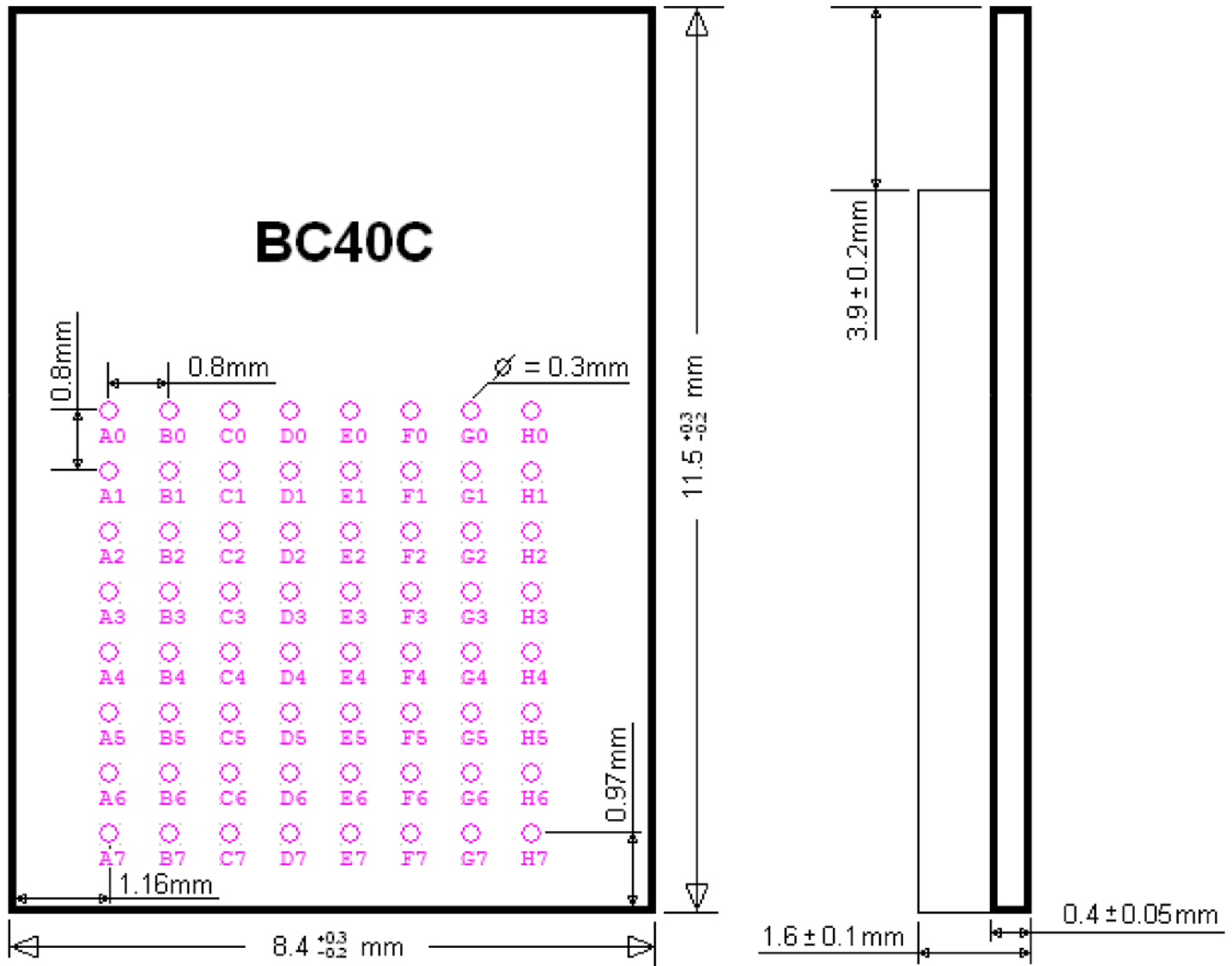

Compact nRF5340 BLE 5.3, 802.15.4 Modules

Ver 1.01 Nov. 2022

BC40M mechanical drawings, top view. Module size is 8.4 (10.1) x 12.7 x 1.6mm, L-shape.

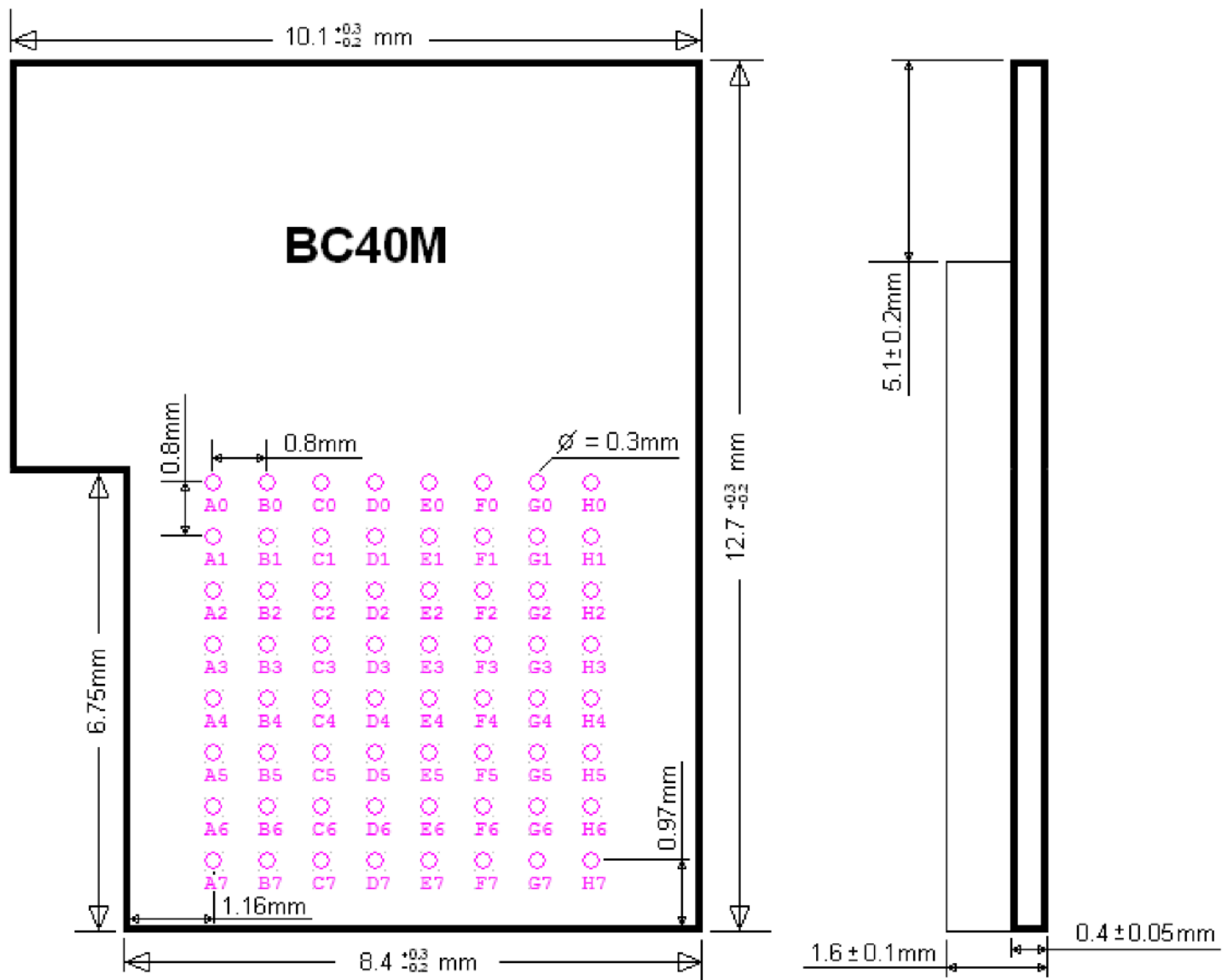

Compact nRF5340 BLE 5.3, 802.15.4 Modules

Ver 1.01 Nov. 2022

BC40P mechanical drawings, top view. Module size is 8.4x9.0x1.6mm.

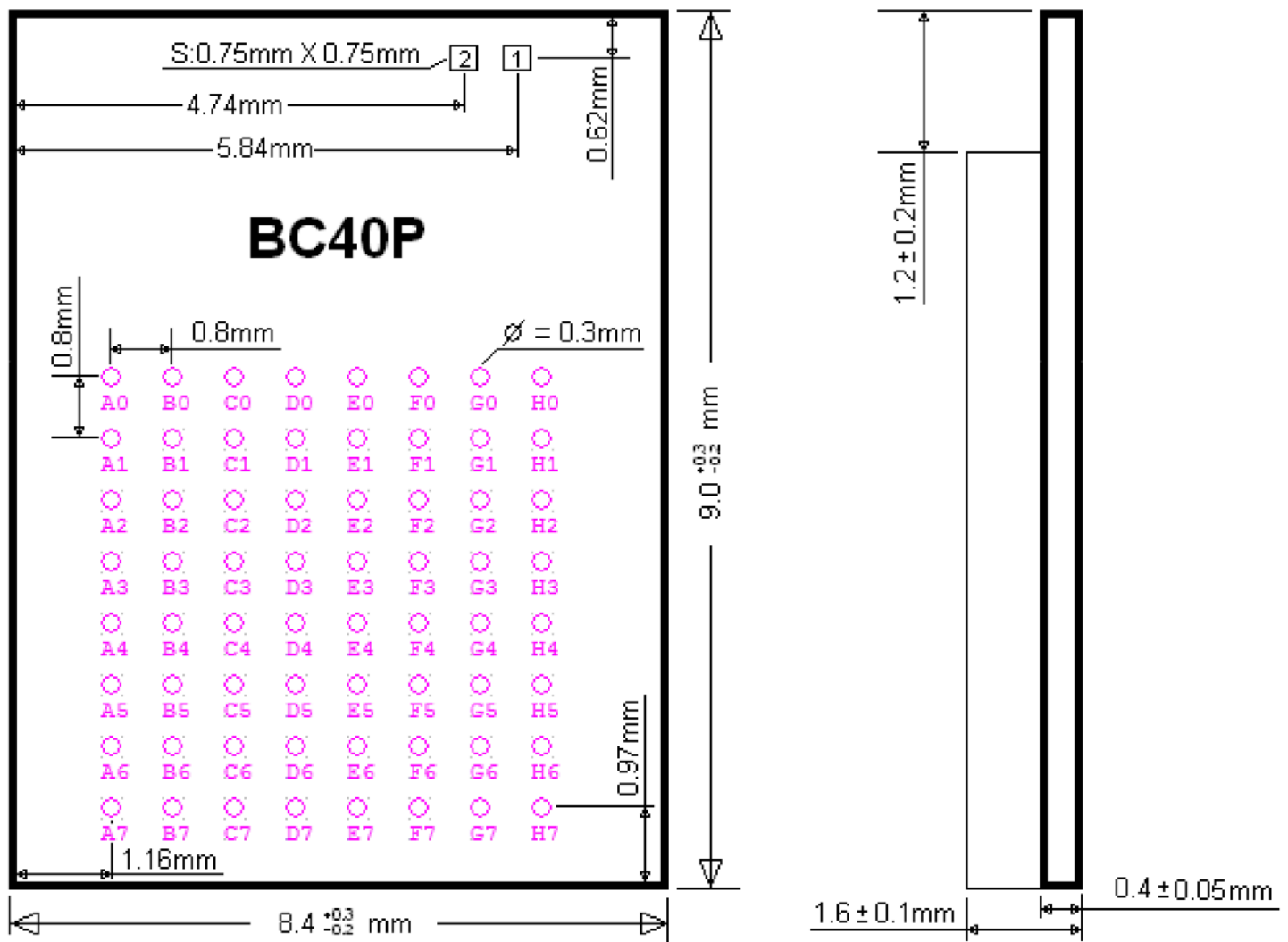

Pin Assignments of BC40C

The followings are BC40C and BC40M pin assignment. Pin functions are in a table in next section. Please refer to Nordic nRF5340 Product Specifications for detailed descriptions and features supported.

https://infocenter.nordicsemi.com/index.jsp?topic=%2Fstruct_nrf53%2Fstruct%2Fnrf5340.html&cp=3_0

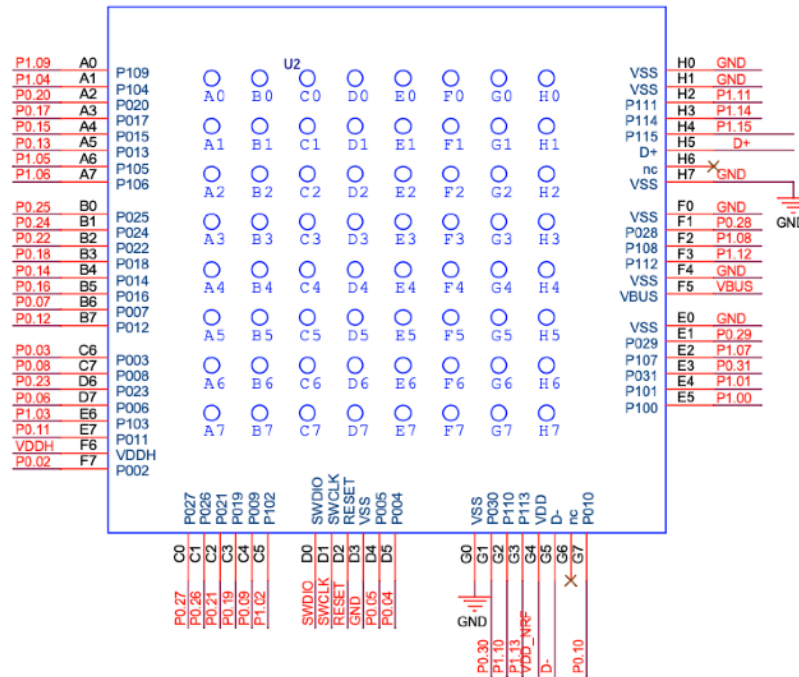

BC40P pin assignment is below. It has two additional pins for external antenna connection.

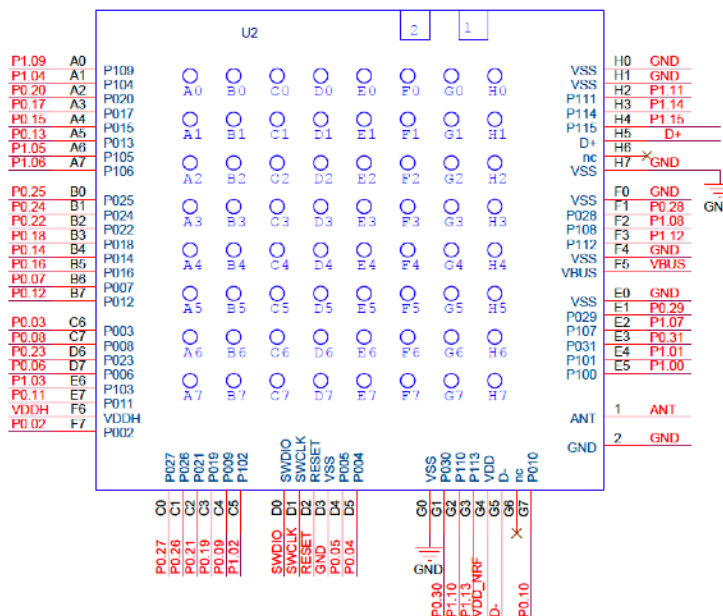

Pin Function

BC40C/M/P	BC40P	nRF5340		
pin#	Only	pin#	pin name	Descriptions
	1		ANT	Connection to an external antenna, BC40P only.
	2		GND	Ground for an external antenna.
A0		H2	P109	GPIO
A1		K3	P104	GPIO
A2		K5	P020	GPIO
A3		L7	P017/QSPI_CLK	GPIO, Quad Serial Peripheral Interface, clock
A4		L9	P015/QSPI2	GPIO, Quad Serial Peripheral Interface, IO2
A5		K10	P013/QSPI0	GPIO, Quad Serial Peripheral Interface, IO0
A6		L3	P105	GPIO
A7		J3	P106	GPIO
B0		L1	P025/AIN4	GPIO, Analog input
B1		K2	P024	GPIO
B2		K4	P022	GPIO
B3		K7	P018/QSPI_CS	GPIO, Quad Serial Peripheral Interface, chip select
B4		K9	P014/QSPI1	GPIO, Quad Serial Peripheral Interface, IO1
B5		K8	P016/QSPI3	GPIO, Quad Serial Peripheral Interface, IO3
B6		J10	P007/AIN3	GPIO, Analog input
B7		J6	P012	GPIO, High speed SPI_DCX
C0		H1	P027/AIN6	GPIO, Analog input
C1		J2	P026/AIN5	GPIO, Analog input
C2		J4	P021	GPIO
C3		J5	P019	GPIO
C4		J9	P009	GPIO, High speed SPI_MOSI
C5		J11	P102/I2C	GPIO, I2C interface
C6		H12	P003/NFC2	GPIO, NFC antenna connection
C7		L12	P008	GPIO, High speed SPI clock
D0		F1	SWDIO	Serial wire debug data for debug and programming
D1		F2	SWDCLK	Serial wire debug clock for debug and programming
D2		G2	/RESET	Reset, active low with internal pull up
D3		A5	VSS	Ground
D4		F10	P005/AIN1	GPIO, Analog input
D5		G10	P004/AIN0	GPIO, Analog input
D6		H3	P023	GPIO
D7		H10	P006/AIN2	GPIO, Analog input
E0		A5	GND	Ground
E1		E2	P029	GPIO
E2		G3	P107	GPIO
E3		C5	P031	GPIO
E4		E10	P101	GPIO
E5		D10	P100	GPIO
E6		K12	P103/I2C	GPIO, I2C interface

Compact nRF5340 BLE 5.3, 802.15.4 Modules

Ver 1.01 Nov. 2022

E7		J7	P011	GPIO, High speed SPI chip select
F0		A5	GND	Ground
F1		E3	P028/AIN7	GPIO, Analog input
F2		F3	P108	GPIO
F3		C7	P112	GPIO
F4		A5	GND	Ground
F5		B11	VBUS	5V input for USB 3.3V regulator
F6		B12	VDDH	High voltage DC power supply, 2.5V to 5.5V
F7		G11	P002/NFC1	GPIO, NFC antenna connection
G0		A5	VSS	Ground
G1		C4	P030	GPIO
G2		E4	P110	GPIO
G3		C8	P113	GPIO
G4		B10	VDD	DC power supply, 1.7V to 3.6V
G5		A11	D-	USB data
G6			NC	No Connect
G7		J8	P010	GPIO, high speed SPI MISO
H0		A5	GND	Ground
H1		A5	GND	Ground
H2		C6	P111	GPIO
H3		C9	P114	GPIO
H4		C10	P115	GPIO
H5		A12	D+	USB data
H6			NC	No Connect
H7		A5	VSS	Ground

Using Internal Load Capacitors for the High Frequency Oscillator

The external load capacitors for the 32MHz crystal are not mounted. An Epson or equivalent +/-10 PPM crystal is connected to XC1 and XC2 pins. The Bluetooth signal frequencies are within specifications if the internal load capacitors are not enabled. Use the following procedures to set the internal load capacitors to 15.5 pF, the Bluetooth signal frequency is measured to be within 5 PPM at 25°C.

The internal load capacitors can be programmed from 7.0 pF to 20 pF in 0.5 pF steps. The addresses and description of registers for programming the value of load capacitors are from the [Nordic nRF5340 Product Specifications](#).

Base address	Domain	Peripheral	Instance	Secure mapping	DMA security	Description	Configuration
0x50004000			OSCILLATORS : S				
0x40004000		APPLICATION OSCILLATORS	US		NA	Oscillator configuration	
			OSCILLATORS : NS				

Programmable capacitance of XC1 and XC2

Bit number	31 30 29 28 27 26 25 24 23 22 21 20 19 18 17 16 15 14 13 12 11 10 9 8 7 6 5 4 3 2 1 0																																		
ID																															B	A	A	A	A
Reset	0x00000000																																		
ID	R/W	Field	Value ID	Value	Description																														
A	RW	CAPVALUE			Value representing capacitance, calculated using provided equation																														
B	RW	ENABLE	Disabled	0	Capacitor disabled (use external caps)																														
			Enabled	1	Capacitor enabled																														

Register	Offset	Security	Description	
XOSC32MCAPS	0x5C4		Programmable capacitance of XC1 and XC2	Retained
XOSC32KI.BYPASS	0x6C0		Enable or disable bypass of LFCLK crystal oscillator with external clock source	Retained
XOSC32KI.INTCAP	0x6D0		Control usage of internal load capacitors	Retained

To program the load capacitance, settings in the file `cpu_app prj.conf`:

```
CONFIG_SOC_ENABLE_LFXO=y
CONFIG_SOC_LFXO_CAP_INT_7PF=y
CONFIG_SOC_HFXO_CAP_INTERNAL=y
CONFIG_SOC_HFXO_CAP_INT_VALUE_X2=25
CONFIG_BUILD_WITH_TFM=y
```

```
## X2=14 7pf 0x400045c4=0x102
## X2=15 7.5pf 0x400045c4=0x103
## X2=16 8pf 0x400045c4=0x104
## X2=17 8.5pf 0x400045c4=0x105
## X2=18 9pf 0x400045c4=0x106
## X2=19 9.5pf 0x400045c4=0x107
```

Compact nRF5340 BLE 5.3, 802.15.4 Modules

Ver 1.01 Nov. 2022

```
## X2=20 10pf      0x400045c4=0x107
## X2=21 10.5pf   0x400045c4=0x108
## X2=22 11pf     0x400045c4=0x109 //BT40 default
## X2=23 11.5pf  0x400045c4=0x10A
## X2=24 12pf    0x400045c4=0x10B
## X2=25 12.5pf  0x400045c4=0x10C //recover default
## X2=26 13pf    0x400045c4=0x10D
## X2=27 13.5pf  0x400045c4=0x10E
## X2=28 14pf    0x400045c4=0x10F
## X2=29 14.5pf  0x400045c4=0x110
## X2=30 15pf    0x400045c4=0x111
## X2=31 15.5pf  0x400045c4=0x112 //BC40 default
## X2=32 16pf    0x400045c4=0x113
.....
```

Alternatively, the load capacitance can be programmed using commands.

```
C:\Users\Leo>nrfjprog --memrd 0x500045c4
0x500045C4: 0000010C      |....|

C:\Users\Leo>nrfjprog --memrd 0x500045c4
0x500045C4: 00000102      |....|

C:\Users\Leo>nrfjprog --memrd 0x500045c4
0x500045C4: 00000102      |....|

C:\Users\Leo>nrfjprog --memrd 0x500045c4
0x500045C4: 00000102      |....|

C:\Users\Leo>nrfjprog --memrd 0x500045c4
0x500045C4: 0000010B      |....|

C:\Users\Leo>nrfjprog --memrd 0x500045c4
0x500045C4: 0000010D      |....|

C:\Users\Leo>nrfjprog --memrd 0x500045c4
0x500045C4: 0000010C      |....|

C:\Users\Leo>
```

Compact nRF5340 BLE 5.3, 802.15.4 Modules

Ver 1.01 Nov. 2022

Mounting BC40M and BC40C on the Host PCB

The following figure shows recommended mounting of BC40M and BC40C (referred as BC40C) module on the host PCB.

- For the best Bluetooth range performance, the antenna area of module shall extend 4.4 mm outside the edge of host PCB board, or 4.4 mm outside the edge of a ground plane.
- The next choice is to place a module on a corner of host PCB, the antenna area shall extend 4.4 mm from the edge of ground plane. Ground plane shall be at least 5 mm from the edge of the antenna area of module.
- We don't recommend mounting BC40C module in the middle of a host PCB.

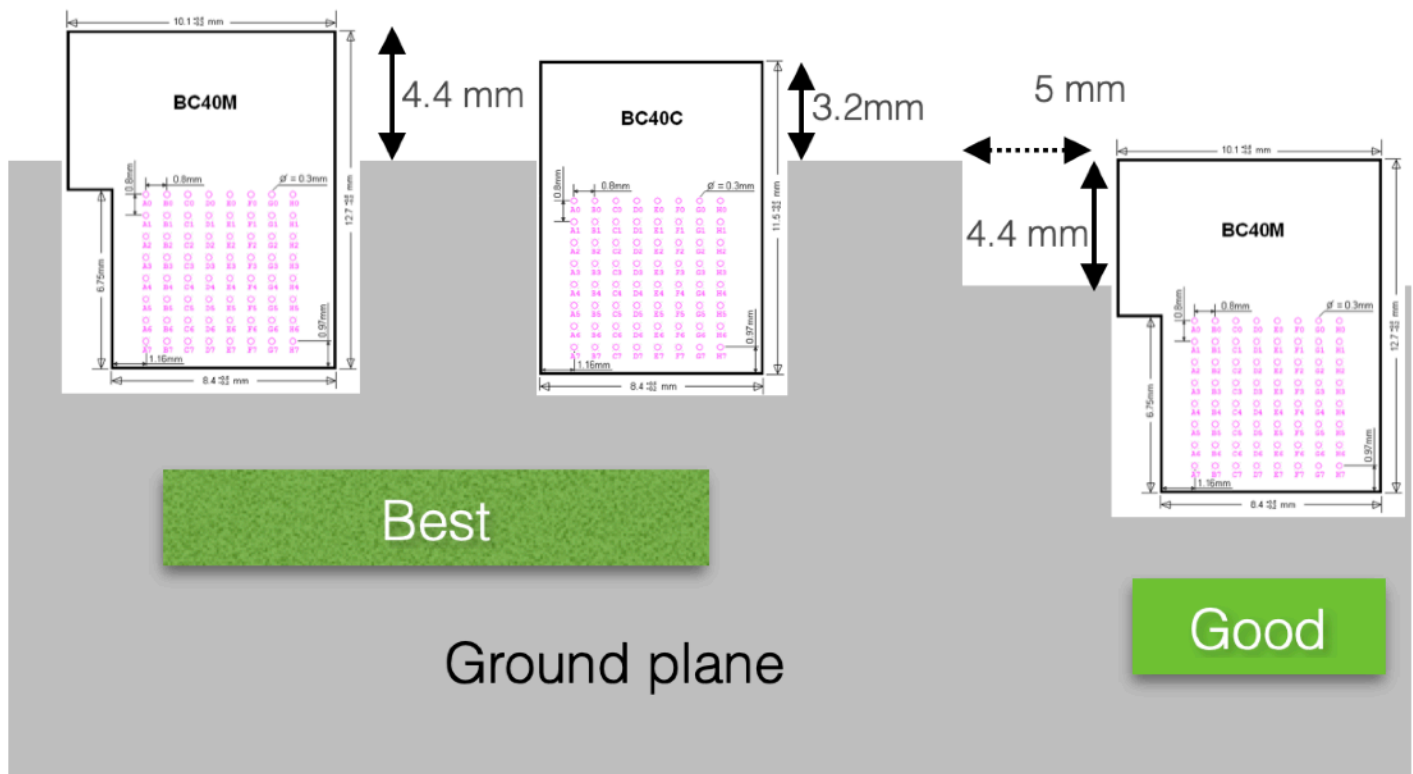

The following figure shows recommended mounting of BC40C module on the host PCB.

- For the best Bluetooth range performance, the antenna area of module shall extend 3.2 mm outside the edge of host PCB board, or 3.2 mm outside the edge of a ground plane.
- The next choice is to place a module on a corner of host PCB, the antenna area shall extend 3.2 mm from the edge of ground plane. Ground plane shall be at least 5 mm from the edge of the antenna area of module.
- We don't recommend mounting BC40C module in the middle of a host PCB.

BC40P shall be mounted near the external connector for an antenna.

For the best Bluetooth range performance, keep all external metal at least 30mm from the antenna area.

Host Board Design for Low Cost or Long Range

On nRF53 series SoCs, Nordic offers various memory options and protocol supports. Fanstel offers various antenna and power amplifier options. A host board can be designed to accommodate these nRF53 modules. Our suggestions for host PCB design:

If your main goal is minimum PCB cost,

- use a 2-sided PCB.
- Use library component from EV-BC40C Gerber files. They can be downloaded from <http://www.fanstel.com/download-document/>. BC40C library component can be used. However, signal routing can be difficult on a 2-sided PCB.

If you main goal is maximum wireless range,

- use a 4 or more layers PCB.
- Use library component from EV-BC40C Gerber files. They can be downloaded from <http://www.fanstel.com/download-document/>.

4. BC40C Evaluation Board

An evaluation board consists of the followings:

- Mini USB cable
- Evaluation board
- 10-conductor cable for connection to Nordic nRF53 DK (DK is not included)

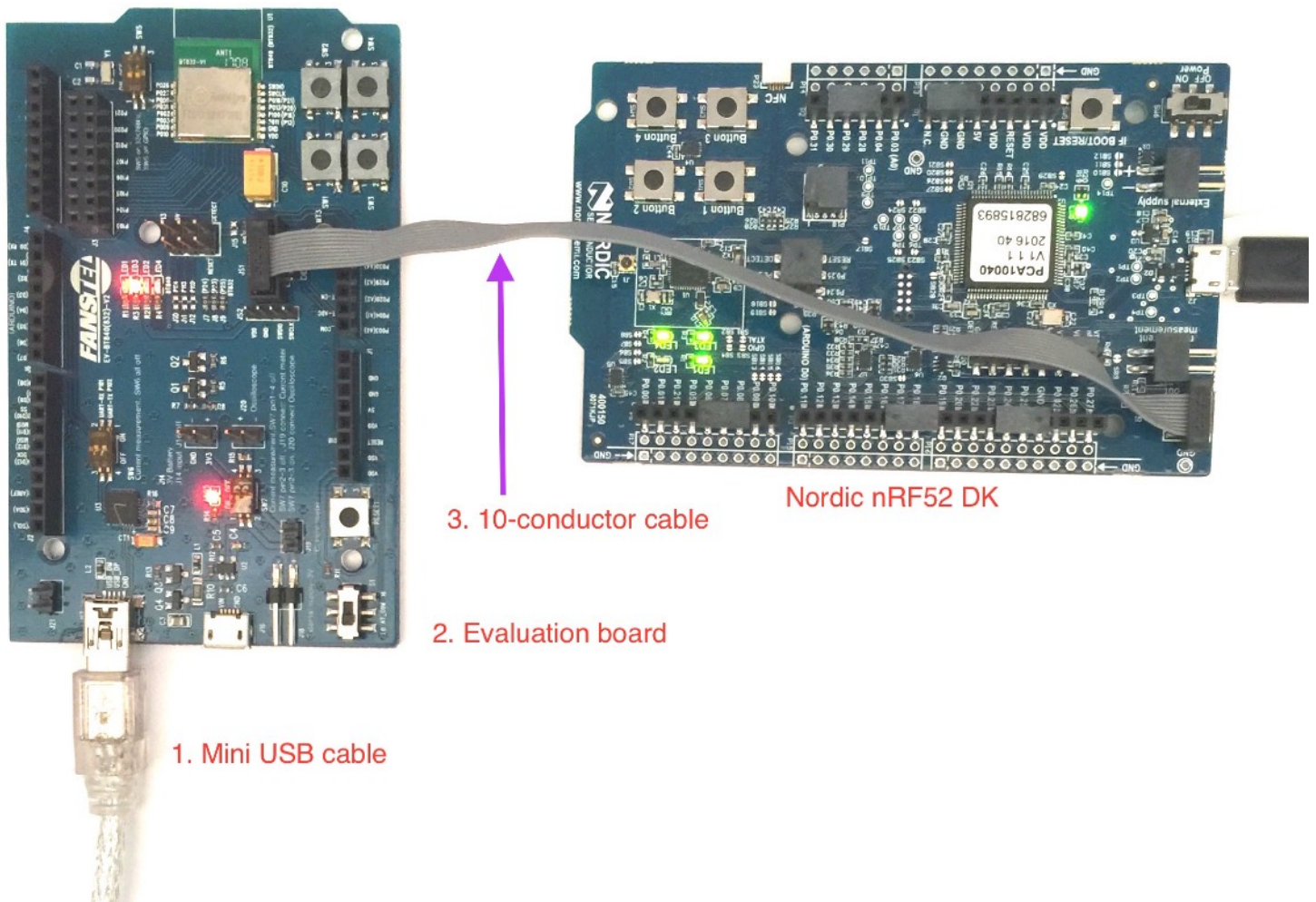

Compact nRF5340 BLE 5.3, 802.15.4 Modules

Ver 1.01 Nov. 2022

EV-BC40C and EV-BC40M Evaluation Board Schematics

BC40C and BC40M evaluation board schematics can be this one or the EV-BC40P schematics on the next page.

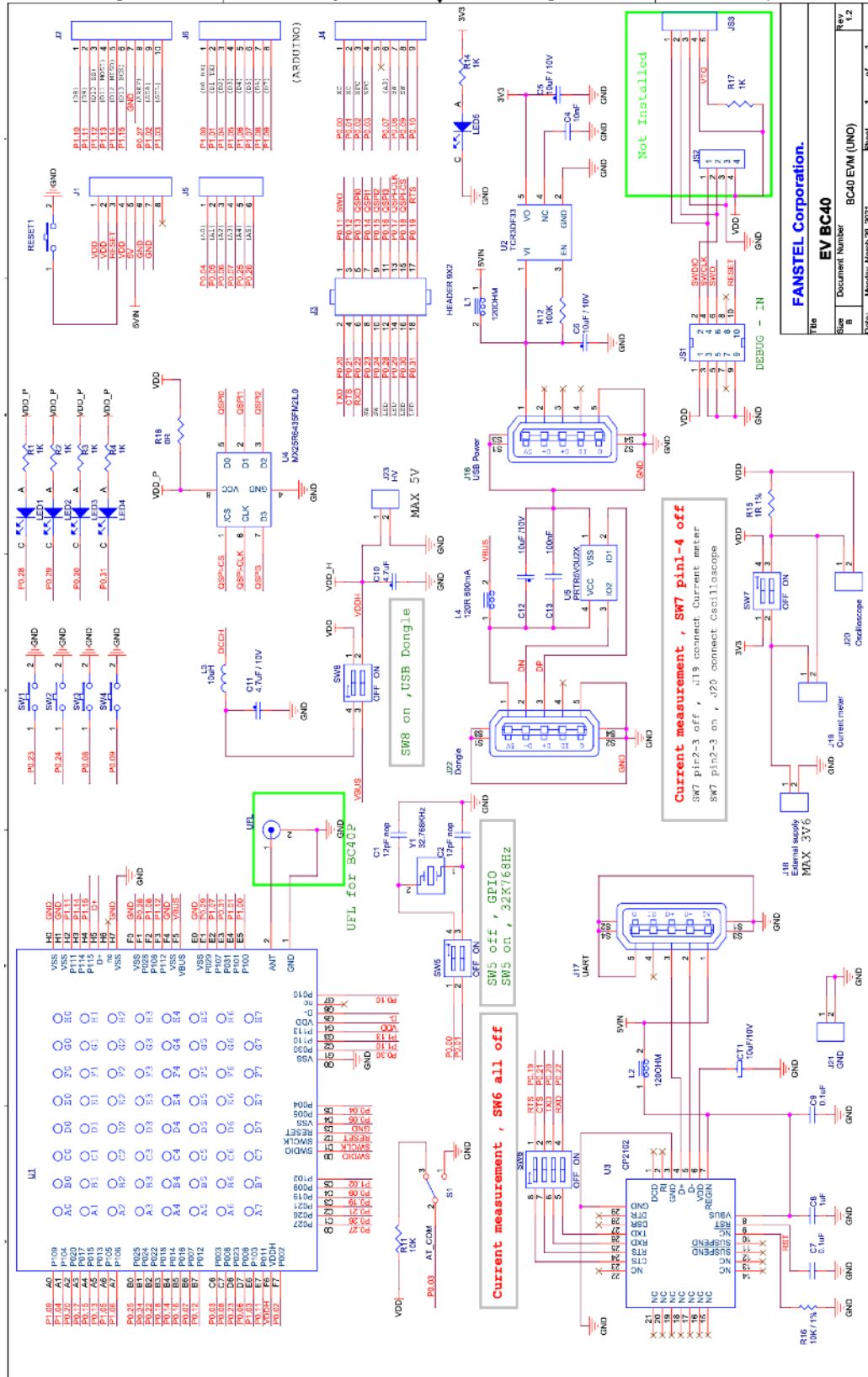

FANSTEEL Corporation.			
EV-BC40			
Document Number BC40 EVM (UNO)			
Rev	1	01	1
Rev	1.2		

Compact nRF5340 BLE 5.3, 802.15.4 Modules

Ver 1.01 Nov. 2022

EV-BC40P Evaluation Board Schematics

BC40P module has two additional pins for an external antenna. They are connected to an u.FL connector on the evaluation board.

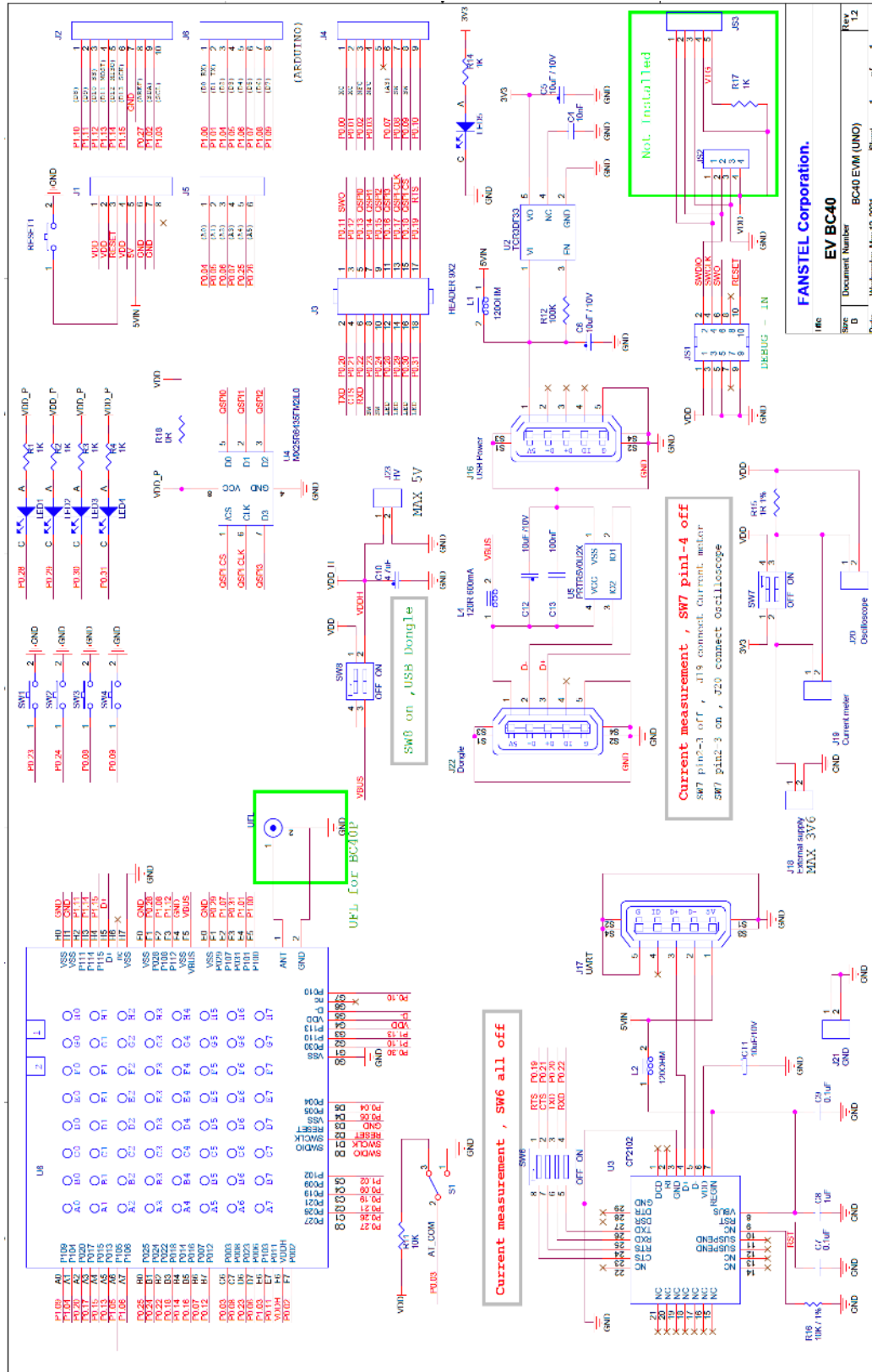

Doc	FANSTEL Corporation.
Doc Name	EV BC40
Doc Number	BC40 EVM (UNO)
Doc Size	12
Doc Date	Wednesday, May 12, 2021
Doc Rev	1.2
Doc Sheet	1 of 1

Nordic Development Tools

A Nordic nRF53 DK is recommended for programming this evaluation board. Nordic development tools can be downloaded from:

https://infocenter.nordicsemi.com/index.jsp?topic=%2Fstruct_nrf53%2Fstruct%2Fnrf5340.html

Many application examples can be downloaded from Nordic website.

Some firmware, Android OS, and iOS app codes can be downloaded from **Bluetooth 5 Codes section** of this Fanstel webpage.

<http://www.fanstel.com/download-document/>

BT40 firmware can be used in all nRF5340 modules without power amplifier, e.g., BT40F, BT40E, BC40C, BC40M, and BC40P.

Android OS Apps

The following Android OS apps are available for download from Google Play Store:

BlueNor nrf5x: to use with Bluetooth 5 stacks, AT commands, or Slave firmware. Master firmware does not connect to a smartphone. Source codes can be downloaded from <http://www.fanstel.com/download-document/>

BlueNor Mesh: to use with BlueNor mesh firmware to send command to any node in a mesh. Node number is displayed when acknowledgement is received. Source codes will be uploaded to Fanstel website when supporting Bluetooth 5.

iOS Apps

The following iOS apps can be downloaded from Apple APP Store.

BlueNor Mesh: to use with BlueNor mesh firmware to send command to any node in a mesh. Node number is displayed when acknowledgement is received.

BlueNor nrf5x firmware, apps, and source codes will be uploaded when ready.

EV-BC40C EvaluationBoard Schematics

Evaluation board schematics and Gerber files can be downloaded from

<http://www.fanstel.com/download-document/>

Evaluation board can be used as a reference design for using modules. EV-BC40C is designed for the BC40C soldering pads with 64 pins. This EV board can also be used for BC40M and BC40P modules. An external antenna required but not included in EV-BC40P.

Suggestion for Battery Power Application

Standby current consumption is important for battery-powered product. To reduce host board area, the followings are embedded in modules:

- 32 MHz, 20PPM main crystal and load capacitors.
- 32.768 KHz, 20PPM sleep crystal and load capacitors.
- Inductors and capacitors required for VDD power supply DC to DC converter.
- Inductors and capacitors required for VDDH power supply DC to DC converter.

No external component is required. DCDC converter shall be enabled to reduce power consumption.

5. Miscellaneous

Soldering Temperature-Time Profile for Re-Flow Soldering

Maximum number of cycles for re-flow is 2. No opposite side re-flow is allowed due to module weight.

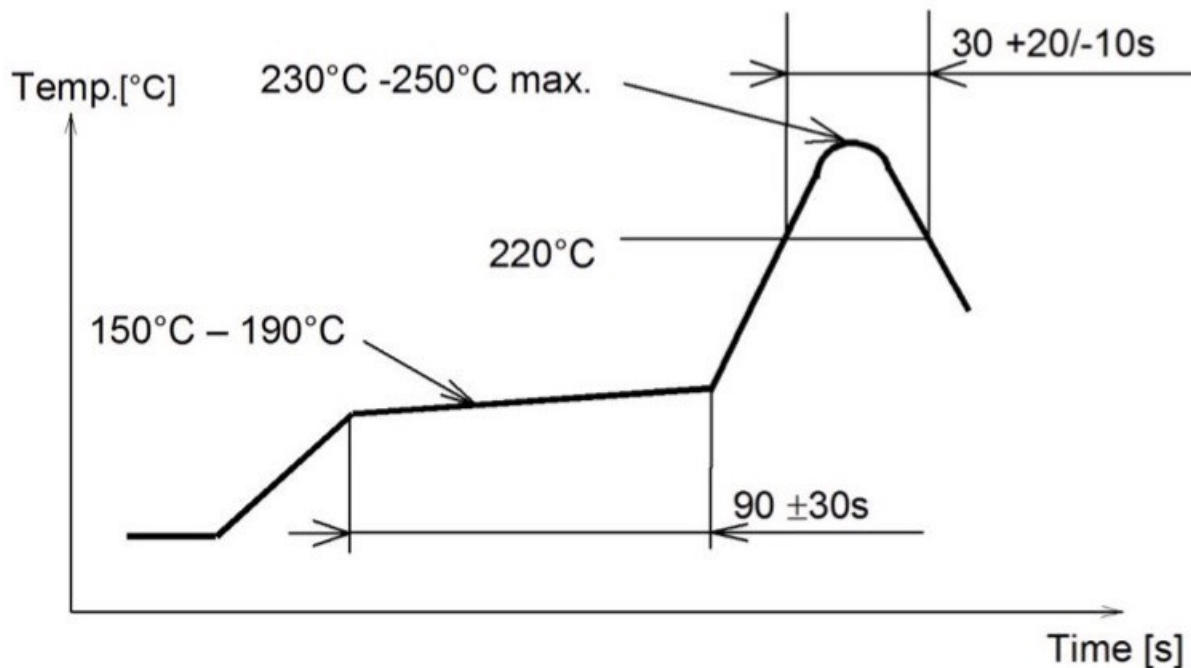

Cautions, Design Notes, and Installation Notes

Failure to follow the guidelines set forth in this document may result in degrading of the product's functions and damage to the product.

Design Notes

- (1) Follow the conditions written in this specification, especially the control signals of this module.
- (2) The supply voltage has to be free of AC ripple voltage (for example from a battery or a low noise regulator output). For noisy supply voltages, provide a decoupling circuit (for example a ferrite in series connection and a bypass capacitor to ground of at least 47uF directly at the module).
- (3) This product should not be mechanically stressed when installed.
- (4) Keep this product away from heat. Heat is the major cause of decreasing the life of these products.
- (5) Avoid assembly and use of the target equipment in conditions where the products' temperature may exceed the maximum tolerance.
- (6) The supply voltage should not be exceedingly high or reversed. It should not carry noise and/or spikes.
- (7) this product away from other high frequency circuits.

Compact nRF5340 BLE 5.3, 802.15.4 Modules

Notes on Antenna and PCB Layout

- (1) Don't use a module with internal antenna inside a metal case.
- (2) For PCB layout:
 - Avoid running any signal line below module whenever possible,
 - No ground plane below antenna,
 - If possible, cut-off the portion of main board PCB below antenna.

Installation Notes

- (1) Reflow soldering is possible twice based on the time-temperature profile in this data sheets. Set up the temperature at the soldering portion of this product according to this reflow profile.
- (2) Carefully position the products so that their heat will not burn into printed circuit boards or affect the other components that are susceptible to heat.
- (3) Carefully locate these products so that their temperatures will not increase due to the effects of heat generated by neighboring components.
- (4) If a vinyl-covered wire comes into contact with the products, then the cover will melt and generate toxic gas, damaging the insulation. Never allow contact between the cover and these products to occur.
- (5) This product should not be mechanically stressed or vibrated when reflowed.
- (6) If you want to repair your board by hand soldering, please keep the conditions of this chapter.
- (7) Do not wash this product.
- (8) Refer to the recommended pattern when designing a board.
- (9) Pressing on parts of the metal cover or fastening objects to the metal will cause damage to the unit.

Usage Condition Notes

- (1) Take measures to protect the unit against static electricity. If pulses or other transient loads (a large load applied in a short time) are applied to the products, check and evaluate their operation before assembly on the final products.
- (2) Do not use dropped products.
- (3) Do not touch, damage or soil the pins.
- (4) Follow the recommended condition ratings about the power supply applied to this product.
- (5) Electrode peeling strength: Do not add pressure of more than 4.9N when soldered on PCB
- (6) Pressing on parts of the metal cover or fastening objects to the metal cover will cause damage.
- (7) These products are intended for general purpose and standard use in general electronic equipment, such as home appliances, office equipment, information and communication equipment.

Storage Notes

- (1) The module should not be stressed mechanically during storage.
- (2) Do not store these products in the following conditions or the performance characteristics of the product, such as RF performance will be adversely affected:
 - Storage in salty air or in an environment with a high concentration of corrosive gas.
 - Storage in direct sunlight
 - Storage in an environment where the temperature may be outside the range specified.
 - Storage of the products for more than one year after the date of delivery storage period.
- (3) Keep this product away from water, poisonous gas and corrosive gas.
- (4) This product should not be stressed or shocked when transported.
- (5) Follow the specification when stacking packed crates (max. 10).

Safety Conditions

These specifications are intended to preserve the quality assurance of products and individual components. Before use, check and evaluate the operation when mounted on your products. Abide by these specifications, without deviation when using the products. These products may short-circuit. If electrical shocks, smoke, fire, and/or accidents involving human life are anticipated when a short circuit occurs, then provide the following failsafe functions, as a minimum.

- (1) Ensure the safety of the whole system by installing a protection circuit and a protection device.
- (2) Ensure the safety of the whole system by installing a redundant circuit or another system to prevent a dual fault causing an unsafe status.

Other Cautions

- (1) This specification sheet is copyrighted. Reproduction of this data sheet is permissible only if reproduction is without alteration and is accompanied by all associated warranties, conditions, limitations, and notices.
- (2) Do not use the products for other purposes than those listed.
- (3) Be sure to provide an appropriate failsafe function on your product to prevent an additional damage that may be caused by the abnormal function or the failure of the product.
- (4) This product has been manufactured without any ozone chemical controlled under the Montreal Protocol.
- (5) These products are not intended for other uses, other than under the special conditions shown below. Before using these products under such special conditions, check their performance and reliability under the said special conditions carefully to determine whether or not they can be used in such a manner.
 - In liquid, such as water, salt water, oil, alkali, or organic solvent, or in places where liquid may splash.











Compact nRF5340 BLE 5.3, 802.15.4 Modules

- In direct sunlight, outdoors, or in a dusty environment
 - In an environment where condensation occurs.
 - In an environment with a high concentration of harmful gas.
- (6) If an abnormal voltage is applied due to a problem occurring in other components or circuits, replace these products with new products because they may not be able to provide normal performance even if their electronic characteristics and appearances appear satisfactory.
- (7) When you have any question or uncertainty, contact Fanstel.

Packaging and Lot Number

Production modules are delivered in reel, 1000 modules in each reel. Lot number for modules made after May 2019, can be used to track silicon version of SoC, module PCB version, and production test code version.



<p>(K) Cust. PO:2630427 </p> <p>(4K) Cust. PO line:00003 </p> <p>(P) Cust. P/N : 1914-1019-2-ND </p> <p>(1T) Lot :D0V218B-0000000 </p> 	<p>(Q) QTY :1000 </p> <p>(1P) MFG P/N : BT840F </p> <p>(6D) Ship Date :20190522 </p> <p>(9D) Date : 1920 </p> <p>(4L) COO: CN </p>
-----------------------------------------------------------------------------------------------------------------------------------------------------------------------------------------------------------------------------------------------------------------------------------------------------------------------------------------------------------------------------------------------------------------------------------------------------------------------------------------------------------------------------------------------------------------------------------	----------------------------------------------------------------------------------------------------------------------------------------------------------------------------------------------------------------------------------------------------------------------------------------------------------------------------------------------------------------------------------------------------------------------------------------------------------------------------------------------------------------------------------------------------------------------------------------

MSL	3/260°C
(E)	e4
RoHS	

Lot: D0 V2 18B - 00 00 000

D0: 2 digits, version number of SoC.

V2: 2 digits, version number of module PCB.

18B: the first 2 digits for production test codes released year and the last digit for month in hex format. A=October, B=November, C=December. 18B was released in November 2018.

00 00 000, 7 digits, reserved for 2nd SoC for modules with 2 SoCs.

FCC LABEL

The Original Equipment Manufacturer (OEM) must ensure that the OEM modular transmitter must be labeled with its own FCC ID number. This includes a clearly visible label on the outside of the final product enclosure that displays the contents shown below. If the FCC ID is not visible when the equipment is installed inside another device, then the outside of the device into which the equipment is installed must also display a label referring to the enclosed equipment

The end product with this module may subject to perform FCC part 15 unintentional emission test requirement and be properly authorized.

This device is intended for OEM integrator only.

Revision History

- April 2021, Ver. 0.80: Initial draft release
- May 2021, Ver. 0.90: Draft revision
- November 2021, Ver. 1.00: Initial release
- Nov. 2022, Ver. 1.01: Instructions for programming the value of internal load capacitors for 32MHz crystal.

Contact Us

United States:

Fanstel Corp.
7466 E. Monte Cristo Ave. Scottsdale AZ 85260
Tel. 1 480-948-4928
Fax. 1-480-948-5459
Email: info@fanstel.com
Website: www.fanstel.com

Taiwan:

Fanstel Corp.
10F-10, 79 Xintai Wu Road
Xizhu, New Taipei City, Taiwan 22101
泛世公司
臺灣省新北市汐止區新臺五路79號10樓之10, 22101
Tel. 886-2-2698-9328
Fax. 886-2-2698-4813
Email: info@fanstel.com
Website: www.fanstel.com

China:

Fanstel Technologies Corp.
11 Jiale Street
Ping-Dih, Long-Gang, Shen Zhen, GD 518117
泛世康科技(深圳)有限公司
廣東省深圳市龍崗區坪地鎮佳樂街11號
Tel. 86-755-8409-0928
Fax. 86-755-8409-0973
QQ. 3076221086
Email: info@fanstel.com
Website: www.fanstel.com