

TEST REPORT

of

RE Directive (2014/53/EU) EN 301 489-1/17

Product : Bluetooth Low Energy (BLE) 5 Module
Brand: FANSTEL
Model: BT832; BT832A; BT832F; BT832AF
Model Difference: Please see page 5 model summaries table
Applicant: Fanstel Corporation, Taipei
Address: 10F-10, No. 79, Sec. 1, Hsin Tai Wu Rd.,
Hsi-Chih, New Taipei City 221 Taiwan

Test Performed by:

International Standards Laboratory Corp. LT Lab.



TEL: +886-3-263-8888 FAX: +886-3-263-8899

No. 120, Lane 180, Hsin Ho Rd., Lung-Tan Dist., Tao Yuan City 325,
Taiwan

Report No.: **ISL-17LR237E489-R2**
Issue Date : **2022/02/07**



Test results given in this report apply only to the specific sample(s) tested and are traceable to national or international standard through calibration of the equipment and evaluating measurement uncertainty herein.

The uncertainty of the measurement does not include in consideration of the test result unless the customer required the determination of uncertainty via the agreement, regulation or standard document specification.

This test report shall not be reproduced except in full, without the written approval of International Standards Laboratory Corp.

VERIFICATION OF COMPLIANCE



Applicant: Fanstel Corporation, Taipei
Equipment Under Test: Bluetooth Low Energy (BLE) 5 Module
Brand Name: FANSTEL
Model Number: BT832; BT832A; BT832F; BT832AF
Model Different: Please see page 5 model summaries table
Date of Test: 2017/08/09 ~ 2017/08/23
Date of EUT Received: 2017/08/09

APPLICABLE STANDARDS	
EN 301 489 –1 v2.2.3: 2019	EN 301 489 –17 v3.2.4: 2020
EMI: EN 55032:2015+AC:2016 Class B	
EMS: EN 55024: 2010+A1:2015	
EN61000-4-2:2009	EN 61000-4-3:2006+A1:2008 +A2:2010

In the configuration tested, the EUT complied with the standards specified above.

Remarks:

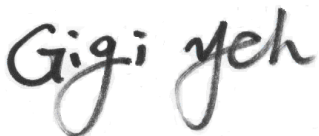
This report details the results of the testing carried out on one sample, the results contained in this test report do not relate to other samples of the same product. The manufacturer should ensure that all products in series production are in conformity with the product sample detailed in this report. This report may only be reproduced and distributed in full. If the product in this report is used in any configuration other than that detailed in the report, the manufacturer must ensure the new system complies with all relevant standards. Any mention of **International Standards Laboratory** or testing done by in connection with distribution or use of the product described in this report must be approved by **International Standards Laboratory** in writing.

Test By:	 <hr/> Jason Chao / Engineer	Date:	2022/02/07
Prepared By:	 <hr/> Gigi Yeh / Engineer	Date:	2022/02/07
Approved By:	 <hr/> Jerry Liu / Technical Manager	Date:	2022/02/07

Version

Version No.	Date	Description
00	2017/08/24	Initial creation of document
01	2022/02/07	Upgrade the standard version (See Note)

Note:

After comparing with two versions of EN 301 489 standards for this application, the difference is as below table. No testing and test report modified is needed, hence, the test configuration and test results of this report are cited from the original report.

Original rule	New rule	Remark
EN 301 489-1 V2.1.1	EN 301 489-1 V2.2.3	No tests need to be update
EN 301 489-17 V3.1.1	EN 301 489-17 V3.2.4	

TABLE OF CONTENTS

1. GENERAL DESCRIPTION.....	5
1.1 DESCRIPTION OF EQUIPMENT UNDER TEST (EUT)	5
1.2 GENERAL DESCRIPTION OF APPLIED STANDARDS	6
1.3 DESCRIPTION OF TEST MODES:.....	6
1.4 TEST FACILITY:.....	8
1.5 MODIFICATION LIST:.....	8
1.6 TEST CONDITION:.....	8
1.7 EQUIPMENT LIST:.....	9
1.8 CONFIGURATION OF TESTED SYSTEM	11
1.9 EXCLUSION BAND	12
2. RADIO DISTURBANCE.....	14
2.1 TEST CONFIGURATION:	14
2.2 SPECIAL CONDITIONS:.....	14
2.3 SUMMARY OF TEST RESULTS.....	14
2.4 ENCLOSURE OF ANCILLARY EQUIPMENT MEASURED ON A STANDALONE BASIS.	15
2.5 DC POWER INPUT/OUTPUT PORTS MEASUREMENT.....	22
2.6 AC MAINS POWER INPUT/OUTPUT PORTS MEASUREMENT.	24
2.7 HARMONIC CURRENT EMISSIONS (AC MAINS INPUT PORT) MEASUREMENT. REFER TO EN 301 489-1 SECTION 8.5	27
2.8 VOLTAGE FLUCTUATIONS AND FLICKER (AC MAINS INPUT PORT) MEASUREMENT. REFER TO EN 301 489-1 SECTION 8.6.....	30
2.9 TELECOMMUNICATION PORT MEASUREMENT. REFER TO EN 301 489-1 SECTION 8.7.....	31
3.IMMUNITY	32
3.1 TEST CONFIGURATION:	32
3.2 SPECIAL CONDITIONS:.....	32
3.3 SUMMARY OF TEST RESULTS:	32
3.4 PERFORMANCE CRITERIA DESCRIPTION:.....	33
3.5 ELECTROSTATIC DISCHARGE MEASUREMENT. REFER TO EN 301 489-1 SECTION 9.3.....	35
3.6 RADIO FREQUENCY ELECTROMAGNETIC FIELD (80 TO 1000MHZ AND 1400 TO 2700MHZ) MEASUREMENT. REFER TO EN 301 489-1 SECTION 9.2	38
3.7 FAST TRANSIENTS, COMMON MODE MEASUREMENT. REFER TO EN 301 489-1 SECTION 9.4.....	40
3.8 SURGES MEASUREMENT. REFER TO EN 301 489-1 SECTION 9.8	41
3.9 RADIO FREQUENCY, COMMON MODE MEASUREMENT. REFER TO EN 301 489-1 SECTION 9.5.....	42
3.10 TRANSIENTS AND SURGES IN THE VEHICULAR ENVIRONMENT MEASUREMENT. REFER TO EN 301 489-1 SECTION 9.6.....	43
3.11 VOLTAGE DIPS AND INTERRUPTIONS MEASUREMENT. REFER TO EN 301 489-1 SECTION 9.7.....	45
APPENDIX 1 ESD TEST POINT	46
APPENDIX 2 PHOTOGRAPHS OF TEST SETUP	48
APPENDIX 3 PHOTOGRAPHS OF EUT.....	54

1. General Description

1.1 DESCRIPTION OF EQUIPMENT UNDER TEST (EUT)

Product Name:	Bluetooth Low Energy (BLE) 5 Module
Brand:	FANSTEL
Model:	BT832; BT832A; BT832F; BT832AF
Model different:	Please see page 5 model summaries table
RF Function	BT4.2

This test report applies for BT4.2

Remark: The above DUT's information was declared by manufacturer. Please refer to the specifications or user's manual for more detailed description.

Model Summaries

module	BT832	BT832A	BT832F	BT832AF
MCU	Cortex M4F	Cortex M4	Cortex M4F	Cortex M4
Flash/RAM	512KB/64KB	192KB/24KB	512KB/64KB	192KB/24KB
Size	14x16x1.9mm	14x16x1.9mm	15x20.8x1.9mm	15x20.8x1.9mm
Average Bluetooth range	100 meters	100 meters	270 meters	270 meters
FCC ID	X8WBT832		X8WBT832	
Canada IC ID	4100A-BT832		4100A-BT832	
Europe				
QDID		97989		97989

1.2 General Description of Applied Standards

The EUT According to the Specifications, it must comply with the requirements of the following standards:

ETSI EN 301 489-1 V2.2.3:

ElectroMagnetic Compatibility (EMC) standard for radio equipment and services;
Part 1: Common technical requirements; Harmonised Standard covering the essential requirements of article 3.1(b) of Directive 2014/53/EU and the essential requirements of article 6 of Directive 2014/30/EU

ETSI EN 301 489-17 V3.2.4:

Part 17: Specific conditions for Broadband Data Transmission Systems; Harmonised Standard covering the essential requirements of article 3.1(b) of Directive 2014/53/EU

1.3 Description of Test Modes:

The transmitter shall be modulated with normal test modulation as specified for that type of equipment. Where transmitters do not have a modulation input port, the internal equipment modulation shall be used.

The wanted signals and/or controls required to establish a communications link shall be defined by the manufacturer.

The transmitter shall be operated at its maximum rated RF output power as specified for that type of equipment. The manufacturer may provide a suitable companion receiver that can be used to set up a communications link and/or to receive messages.

The tests shall be made exercising all primary functions in the most representative mode consistent with typical applications. The test sample shall be configured in a manner consistent with typical installation practice.

Test Plan

		Config 1	Config 2
	Applicable standard	EN 301489	
	Accessories	UE + Smart phone	UE + Smart phone
EN No.	Description	<i>BT link(BT832F)</i>	<i>BT link(BT832)</i>
8.2	radiated emission (30M-1GHz) (1-6GHz)	measured	pretest
8.3	conducted emission (DC Power)	N/A	N/A
8.4	conducted emission (AC Power)	measured	N/A
8.5	harmonic current emissions	N/A	N/A
8.6	voltage fluctuations and flicker	N/A	N/A
8.7	Telecommunication emission	N/A	N/A
9.2	RF electromagnetic field (80MHz to 6GHz)	measured	measured
9.3	electrostatic discharge	measured	measured
9.4	fast transients common mode	N/A	N/A
9.5	RF common mode 0,15MHz to 80MHz	N/A	N/A
9.6	transients and surges	N/A	N/A
9.7	voltage dips and interruptions	N/A	N/A
9.8	surges, line to line and line to ground	N/A	N/A

1.4 Test Facility:

The 10m anechoic chamber radiated emission measurement facilities used to collect the data are located at <Lung-Tan LAB> Address: No. 120, Lane 180, Hsin Ho Rd. Lung-Tan Dist., Tao Yuan City 325, Taiwan, The sites are constructed in conformance with the requirements of ANSI C63.7, ANSI C63.4 and CISPR Publication 22.

The 966 anechoic chamber radiated emission measurement (Above 1GHz) facilities used to collect the data are located at <Lung-Tan LAB> Address: No. 120, Lane 180, Hsin Ho Rd. Lung-Tan Dist., Tao Yuan City 325, Taiwan, The sites are constructed in conformance with the requirements of ANSI C63.7, ANSI C63.4 and CISPR Publication 22.

The AC power line conducted emission, flicker and all of immunity measurement facilities used to collect the data are located at <Lung-Tan LAB> Address: No. 120, Lane 180, Hsin Ho Rd. Lung-Tan Dist., Tao Yuan City 325, Taiwan, The sites are constructed in conformance with the requirements of ANSI C63.7, ANSI C63.4 and CISPR Publication 22.

1.5 Modification List:

No modification by International Standards Laboratory.

1.6 Test Condition:

Refer to EN 301 489-1, Section 4 and EN 301 489-17, Section4 for the details.

1.7 Equipment List:

Location Con02	Equipment Name	Brand	Model	S/N	Last Cal. Date	Next Cal. Date
Conduction 02	LISN 20	R&S	ENV216	101477	07/15/2017	07/15/2018
Conduction 02	LISN 23	FCC	FCC-LISN-50-25-2-01	07038	12/30/2016	12/30/2017
Conduction 02	Conduction 02-1 Cable	WOKEN	CFD 300-NL	Conduction 02 -1	08/29/2016	08/29/2017
Conduction 02	EMI Receiver 14	ROHDE&SCHWARZ	ESCI	101034	06/06/2017	06/06/2018
Conduction 02	ISNT4 07	Teseq GmbH	ISN T400A	30449	07/20/2017	07/20/2018
Conduction 02	ISN T8 10	Teseq GmbH	ISN T800	42773	07/18/2017	07/18/2018

Location Chamber02	Equipment Name	Brand	Model	S/N	Last Cal. Date	Next Cal. Date
	BILOG Antenna 17	Schwarzbeck	Schwarzbeck VULB 9168+EMCI-N-6-05	645	02/07/2017	02/07/2018
Radiation (Chamber02)	Preamplifier 25	EMCI	EMC9135	980295	01/18/2017	01/18/2018
Radiation (Chamber02)	Coaxial Cable Chmb 02-10M-02	MIYAZAK	8D-FB	Chmb 02-10M-02	08/29//2016	08/29/2017
Radiation (Chamber02)	EMI Receiver 12	ROHDE & SCHWARZ	ESCI	100804	07/10/2017	07/10/2018

Chamber 19(966 Chamber)					
EQUIPMENT TYPE	MFR	MODEL NUMBER	SERIAL NUMBER	LAST CAL.	CAL DUE.
Spectrum Analyzer 21(3Hz-44GHz)	Agilent	N9030A	MY51360021	11/14/2016	11/13/2017
EMI Receiver	SCHWARZBECK	FCVU1534	1534149	11/30/2016	11/29/2017
Horn antenna (1G-18G)	SCHWARZBECK	9120D	9120D-1627	07/21/2017	07/20/2018
Horn antenna (18G-26G)	Com-power	AH-826	081001	07/23/2017	07/22/2019
Preamplifier (9k-1000M)	HP	8447F	3113A06362	11/13/2016	11/12/2017
Preamplifier(1G-26G)	Agilent	8449B	3008A02471	08/25/2016	08/24/2017
Preamplifier (26G-40G)	MITEQ	JS4-26004000-27-5A	818471	07/22/2017	07/21/2019
RF Cable (9k-18G)	HUBER SUHNER	SUCOFLEX 104A	MY1397/4A	08/25/2016	08/24/2017
RF cable (18G~40G)	HUBER SUHNER	Sucoflex 102	27963/2&37421/2	11/03/2015	11/02/2017

Location	Equipment Name	Brand	Model	S/N	Last Cal. Date	Next Cal. Date
EN61K-4-2	ESD Gun 06	EM TEST	Dito	V0729102699	07/05/2017	07/05/2018
EN61K-4-2	ESD Gun 07	NoiseKen	ESS-2002EX	ESS0878638	02/06/2017	02/06/2018
EN61K-4-3	Broadband Log-Periodic Antenna	AR	AT1080	310698	N/A	N/A
EN61K-4-3	Horn Antenna RF-01	AR	ATS700M11 G	0335864	N/A	N/A
EN61K-4-3	Amplifier 80Mz~1GHz 250W	AR	250W1000A	312494	N/A	N/A
EN61K-4-3	Amplifier 800MHz~4.2GHz 50W	AR	50S1G4M1	312762	N/A	N/A
EN61K-4-3	Amplifier 4.0~8.0GHz 35W	AR	35S4G8AM1	0335752	N/A	N/A
EN61K-4-3	Broadband Coupler 80M~1GHz	Amplifier Research	DC6180A	0341805	N/A	N/A
EN61K-4-3	Coaxial Cable	INSULATED	NPS-4806-23 60-NP3	108599.003.01.0 3	N/A	N/A
EN61K-4-3	Broadband Coupler 0.8G~4.26GHz	AR	DC7144A	0335226	N/A	N/A
EN61K-4-3	Broadband Coupler 4G~8GHz	AR	DC7350A	0335817	N/A	N/A
EN61K-4-3	Signal Generator 07	ROHDE& SCHWARZ	SMB100A	107780	10/05/2016	10/05/2017
EN61K-4-4	EFT and SURGE Test System	EM TEST	UCS-500 M6B	V0728102674	02/08/2017	02/08/2018
EN61K-4-4	Capacitive Coupling Clamp	EM TEST	HFK	0907-106	02/08/2017	02/08/2018
EN61K-4-5	CDN-UTP8 ED3	EMC-PARTNER	CDN-UTP8	1509	04/18/2017	04/18/2018
EN61K-4-5	SURGE-TESTER	EMC Partner	MIG0603IN3	523	04/14/2017	03/10/2018
EN61K-4-6	CDN M2+M3 02	Frankonia	CDN M2+M3	A3011024	09/14/2015	09/14/2017
EN61K-4-6	CDN T2 04	FCC Inc.	FCC-801-T2	02067	08/16/2016	08/16/2017
EN61K-4-6	CDN T4 06	FCC Inc.	FCC-801-T4	02017	08/04/2016	08/04/2017
EN61K-4-6	CDN T8-10 1	Teseq GmbH	CDN T8 10	41242	02/22/2017	02/22/2018
EN61K-4-6	Coaxial Cable 4-6 02-1			4-6 02-1	N/A	N/A
EN61K-4-6	Conducted Immunity Test System 02	Frankonia	CIT-10-75-D C	126B1301/2014	02/23/2017	02/23/2018
EN61K-4-6	EM-Clamp	Schaffner	KEMZ-801	19215	10/11/2016	10/11/2017
EN61K-4-11	Voltage Dip and UP Simulator	NoiseKen	VDS-2002	VDS0640162	11/10/2016	11/10/2017
EN61K-4-34	Voltage Dip and UP Simulator 100A	EM Test	PFS-503	V0728102676	02/07/2017	02/07/2018
EN61K-3-2/3, EN61K-3-11-1 2	(Harmonic/Flicker) MX Series CTSH Compliance Test System	California Instruments	MX60T04GH 10400	72793	06/20/2017	06/20/2018

PS: N/A => The equipment does not need calibration.

1.8 Configuration of Tested System

Fig. 1-1 Configuration

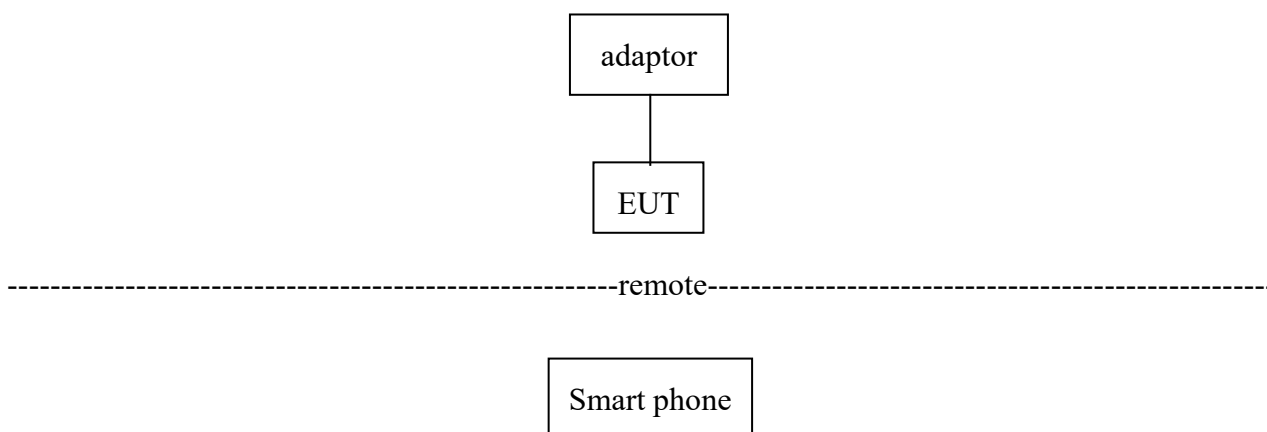

Table 1-1 Support Equipment Used in Tested System

Item	Equipment	Mrf/Brand	Model name	Series No	Data Cable	Power Cable
1	Adaptor	TPT	MII050200	N/A	N/A	Non-Shielded /1.2M
2	Smart phone	hTC	PL99110	N/A	N/A	N/A

I/O Cable Condition of EUT and Support Units

Description	Path	Cable Length	Cable Type	Connector Type
USB charge cable	Adaptor to EUT	1.2M	Non-shielded(With core)	Metal Head

Note: All the above equipment/cables were placed in worse case positions to maximize emission signals during emission test.

Grounding: Grounding was in accordance with the manufacturer's requirements and conditions for the intended use.

1.9 Exclusion band

For EN301489-1

Exclusion band for transmitters or the transmitter part of transceivers

Channelized Equipmen

For channelized equipment the exclusion band shall extend 250 % of the channel width either side of the transmitter centre frequency.

NOTE: Exclusion band of 250 % is based on the ITU Radio Regulations [i.8], as the boundary between OOB and Spurious Domain.

Non-Channelized Equipment

For non-channelized equipment the exclusion band shall extend 250 % of the occupied bandwidth either side of the transmitter centre frequency.

NOTE: Exclusion band of 250 % is based on the ITU Radio Regulations [i.8], as the boundary between OOB and Spurious Domain.

Exclusion band for receivers or the receiver part of transceivers

Channelized Equipment

For channelized equipment the exclusion band shall be calculated by using the following formulae:

For the lower edge for the exclusion band:

$$EXband(lower) = BandRX(lower) - nChWRX$$

and for the upper edge of the exclusion band:

$$EXband(upper) = BandRX(upper) + nChWRX$$

Where n = number of channel widths required for exclusion band.

For equipment that support multiple channel widths the Channel Width used should be the widest support by the EUT.

Where the present document is being used in a stand-alone basis (i.e. with no reference to other relevant radio technology parts of ETSI EN 301 489 series [i.13]), the value of n shall be 1.

Non-Channelized Equipment

For non-channelized equipment the exclusion band shall be calculated by using the following formula: For the lower edge for the exclusion band:

$$EXband(lower) = BandRX(lower) - nBWRX$$

and for the upper edge of the exclusion band:

$$EXband(upper) = BandRX(upper) + nBWRX$$

Where n = multiple of whole bandwidths required to define exclusion band.

Bandwidth of Receiver is the occupied bandwidth of the corresponding transmitter signal.

Where the present document is being used in a stand-alone basis (i.e. with no reference to other relevant radio technology parts of ETSI EN 301 489 series [i.13]), the value of n shall be 1

For EN301489-17

The frequencies on which the transmitter part of the EUT is intended to operate shall be excluded from conducted and radiated emission measurements when performed in transmit mode of operation.

The exclusion band for immunity testing of equipment operating in the 2,4 GHz band shall be:
lower limit of exclusion band = lowest allocated band edge frequency -120 MHz, i.e. 2 280 MHz;
upper limit of exclusion band = highest allocated band edge frequency +120 MHz, i.e. 2 603,5MHz.

The exclusion band for immunity testing of equipment operating in the 5 GHz Wi-Fi band shall be:
lower limit of exclusion band = lowest allocated band edge frequency -270 MHz, i.e. 4 880 MHz;
upper limit of exclusion band = highest allocated band edge frequency +270 MHz, i.e. 5 995 MHz.

The exclusion band for immunity testing of equipment operating in the 5,8 GHz band shall be:
lower limit of exclusion band = lowest allocated band edge frequency -270 MHz, i.e. 5 455 MHz;
as the immunity requirements have an upper frequency range of 6 GHz and any upper edge exclusion band would be greater than this for the 5,8 GHz band. The above frequency shall also be regarded as the upper end of the test range.

2. Radio Disturbance

EN 301 489-17

2.1 Test Configuration:

Refer to EN 301 489-1, Section 8.1.

2.2 Special Conditions:

EN301489-17

No special conditions shall apply to UE in the scope of the present document.

2.3 Summary of Test Results

Test Items	Reference section	Result
Enclosure of ancillary equipment measured on a standalone basis, EN55032, Class B	EN 301 489-1 Section 8.2 EN55032 Annex A.2	PASS
DC mains power input/output ports	EN 301 489-1 Section 8.3	N/A
AC mains power input/output ports EN55032, Class B	EN 301 489-1 Section 8.4 EN55032 Annex A.2	PASS
Harmonic current emission, Class A	EN 301 489-1 Section 8.5 EN61000-3-2	N/A
Voltage fluctuations and flicker	EN 301 489-1 Section 8.6 EN61000-3-3	N/A
Telecommunication Port	EN 301 489-1 Section 8.7 EN55022 Section 5.2	N/A

2.4 Enclosure of ancillary equipment measured on a standalone basis.

2.4.1 Test Method:

Standard	Date	Description
EN 55032	2015+AC: 2016	Limits and methods of measurement of radio interference characteristics of information technology equipment.

Limit: Class B

Table clause	Frequency range MHz	Measurement		Class B limits dB(μ V/m)
		Distance m	Detector type/ bandwidth	OATS/SAC (see Table A.1)
A4.1	30 – 230	10	Quasi Peak / 120 kHz	30
	230 – 1 000			37
A4.2	30 – 230	3		40
	230 – 1 000			47

Apply only table clause A4.1 or A4.2 across the entire frequency range.

Table clause	Frequency range MHz	Measurement		Class B limits dB(μ V/m)
		Distance m	Detector type/ bandwidth	FSOATS (see Table A.1)
A5.1	1 000 – 3 000	3	Average/ 1 MHz	50
	3 000 – 6 000			54
A5.2	1 000 – 3 000		Peak/ 1 MHz	70
	3 000 – 6 000			74

Apply A5.1 and A5.2 across the frequency range from 1 000 MHz to the highest required frequency of measurement derived from Table 1.

Highest internal frequency (F_x)	Highest measured frequency
$F_x \leq 108$ MHz	1 GHz
108 MHz $< F_x \leq 500$ MHz	2 GHz
500 MHz $< F_x \leq 1$ GHz	5 GHz
$F_x > 1$ GHz	$5 \times F_x$ up to a maximum of 6 GHz

NOTE 1 For FM and TV broadcast receivers, F_x is determined from the highest frequency generated or used excluding the local oscillator and tuned frequencies.

NOTE 2 F_x is defined in 3.1.19.

The highest internal source of an EUT is above 1GHz.

2.4.2 Test Procedure:

1. EUT was placed on an 0.8m wooden table.
2. Set up EUT with support units and turn on the power of all equipment.
3. Link the EUT with Telecommunication tester, setup the test mode. The transmitter operating at continuously mode and max output rated power.
4. The receive antenna is placed at 10m or 3m (3m for above 1GHz) distance from the EUT and search height from 1-4m.
5. The turntable was slowly rotated to locate the direction of maximum emission. Once maximum direction is determined, the search antenna was raised and lowered in both vertical and horizontal polarizations.

2.4.3 Test Instruments:

Refer to section 1.7 in this report

2.4.4 Test SET-UP (Block Diagram of Configuration)

(A) Radiated Emission Test Set-Up, Frequency Below 1000MHz

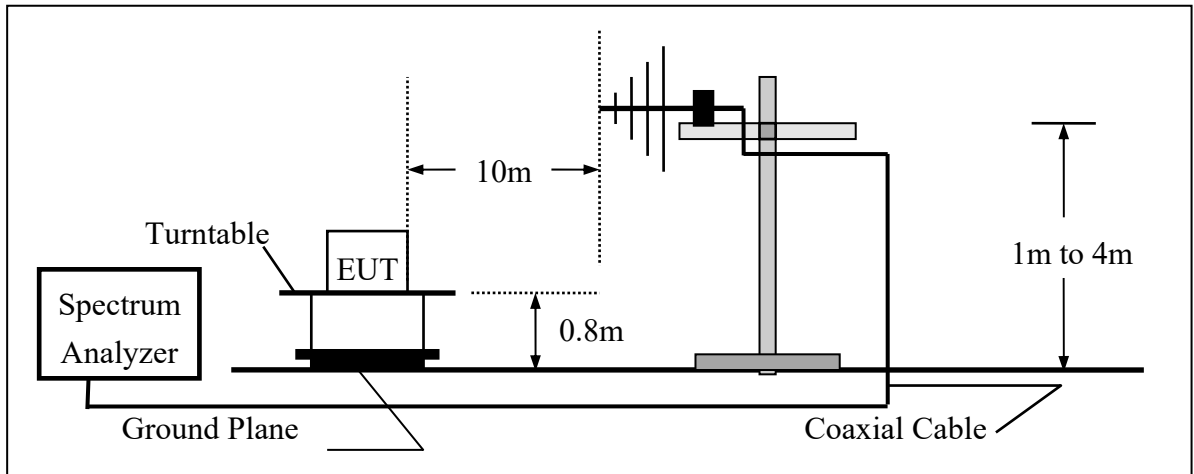

(B) Radiated Emission Test Set-UP Frequency Over 1 GHz

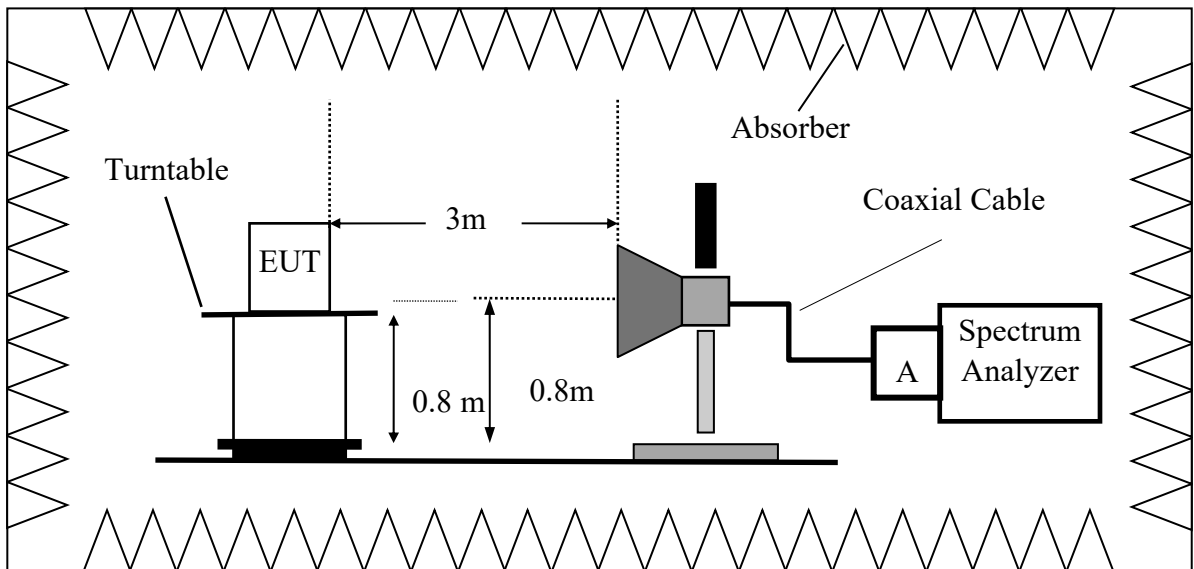

Radiated Emission Measurement Data

Operation Mode	Config 1	Test Date	2017/08/14
Test by	Jason	Pol	Vertical



Address: No. 120, Lane 180, Hsin Ho Rd., Lung-Tan Dist.,
Tao Yuan City 325, Taiwan.
Tel: 03-4071718

Radiated Emission Measurement
Date: 2017/8/14

Operator: Kevin Chan
Temperature: 26 °C
Humidity: 60 %

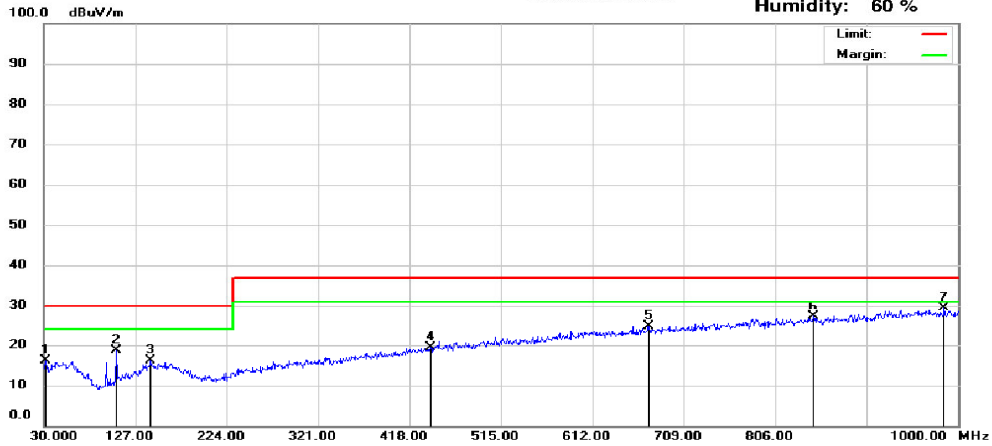

Site : Chamber 12

Polarization: *Vertical*

Mk.	Frequency (MHz)	RX_R (dBuV)	Correct Factor (dB/m)	Emission (dBuV/m)	Limit (dBuV/m)	Margin (dB)	Ant.Pos (cm)	Tab.Pos (deg.)	Detector
1	31.94	34.69	-18.64	16.05	30.00	-13.95	366	360	peak
2	106.63	38.79	-20.11	18.68	30.00	-11.32	100	228	peak
3	143.49	32.48	-16.39	16.09	30.00	-13.91	100	110	peak
4	440.31	30.27	-10.89	19.38	37.00	-17.62	300	235	peak
5	672.14	31.53	-6.79	24.74	37.00	-12.26	300	257	peak
6	846.74	31.49	-4.45	27.04	37.00	-9.96	150	316	peak
7	985.45	31.76	-2.28	29.48	37.00	-7.52	400	205	peak



International Standard Laborator
Company Address:No.120,Lane 180, San Ho tsuen Hsin Ho Road
Lung-Tan Hsiang Tao Yuan Count, Taiwan,ROC
Tel:(03)4071718
Fax:(03)4071738
Web:www.isl.com.tw

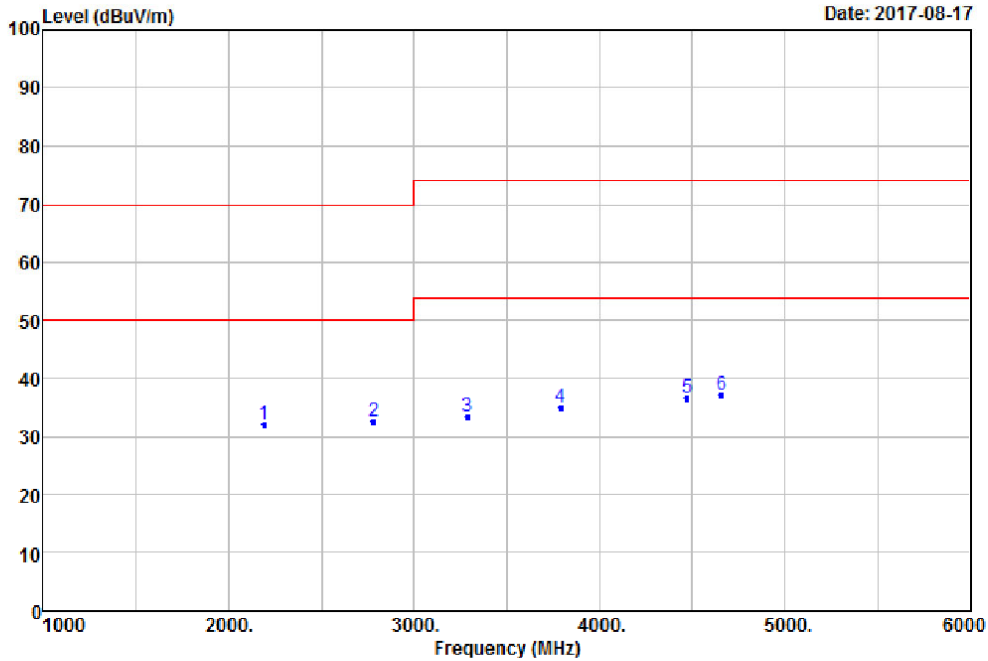

Condition: 55032 CLASS B PK 3m VERTICAL
Site : Chamber 19

Operator : jason

	Freq	Read Level	Factor	Level	Limit Line	Over Limit	Remark	Pol/Phase
	MHz	dBuV	dB/m	dBuV/m	dBuV/m	dB		
1	2190.00	35.21	-3.26	31.95	70.00	-38.05	Peak	VERTICAL
2	2780.00	35.10	-2.49	32.61	70.00	-37.39	Peak	VERTICAL
3	3290.00	35.19	-1.90	33.29	74.00	-40.71	Peak	VERTICAL
4	3790.00	35.09	-0.08	35.01	74.00	-38.99	Peak	VERTICAL
5	4475.00	34.37	2.17	36.54	74.00	-37.46	Peak	VERTICAL
6	4660.00	34.27	2.79	37.06	74.00	-36.94	Peak	VERTICAL

Operation Mode	Config 1	Test Date	2017/08/14
Test by	Jason	Pol	Horizontal



Address: No. 120, Lane 180, Hsin Ho Rd., Lung-Tan Dist.,
Tao Yuan City 325, Taiwan.
Tel: 03-4071718

Radiated Emission Measurement
Date: 2017/8/14

Operator: Kevin Chan
Temperature: 26 °C
Humidity: 60 %

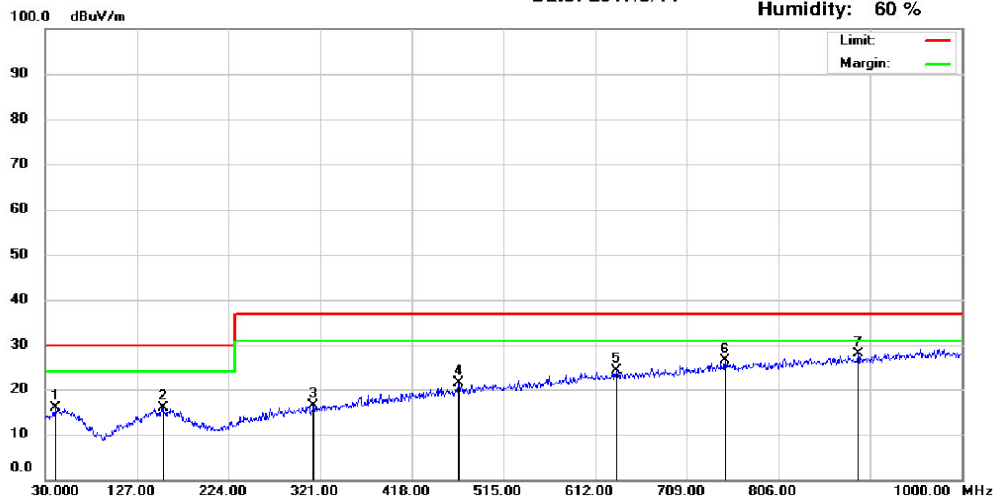

Site : Chamber 12

Polarization: *Horizontal*

Mk.	Frequency (MHz)	RX_R (dBuV)	Correct Factor(dB/m)	Emission (dBuV/m)	Limit (dBuV/m)	Margin (dB)	Ant.Pos (cm)	Tab.Pos (deg.)	Detector
1	40.67	33.49	-17.65	15.84	30.00	-14.16	250	298	peak
2	154.16	31.84	-15.90	15.94	30.00	-14.06	150	81	peak
3	314.21	30.80	-14.45	16.35	37.00	-20.65	350	176	peak
4	467.47	31.58	-10.32	21.26	37.00	-15.74	150	190	peak
5	634.31	31.51	-7.32	24.19	37.00	-12.81	200	45	peak
6	749.74	31.88	-5.38	26.50	37.00	-10.50	200	196	peak
7	890.39	31.78	-3.79	27.99	37.00	-9.01	200	104	peak



International Standard Laborator
Company Address:No.120,Lane 180, San Ho tsuen Hsin Ho Road
Lung-Tan Hsiang Tao Yuan Count, Taiwan,ROC
Tel:(03)4071718
Fax:(03)4071738
Web:www.isl.com.tw

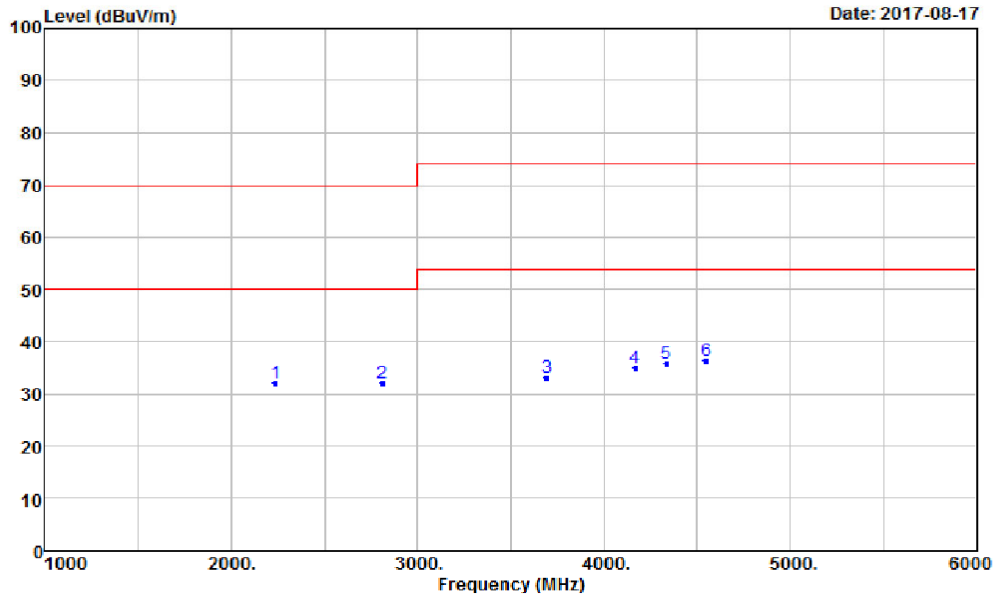

Condition: 55032 CLASS B PK 3m HORIZONTAL
Site : Chamber 19

Operator : jason

	Freq	Read Level	Factor	Level	Limit Line	Over Limit	Remark	Pol/Phase
	MHz	dBuV	dB/m	dBuV/m	dBuV/m	dB		
1	2235.00	35.04	-3.15	31.89	70.00	-38.11	Peak	HORIZONTAL
2	2810.00	34.33	-2.45	31.88	70.00	-38.12	Peak	HORIZONTAL
3	3695.00	33.33	-0.35	32.98	74.00	-41.02	Peak	HORIZONTAL
4	4170.00	33.66	1.22	34.88	74.00	-39.12	Peak	HORIZONTAL
5	4335.00	34.15	1.70	35.85	74.00	-38.15	Peak	HORIZONTAL
6	4550.00	33.95	2.41	36.36	74.00	-37.64	Peak	HORIZONTAL

2.5 DC power input/output ports measurement.

2.5.1 Test Method:

Standard	Date	Description
EN 55032	2015+AC: 2016	Limits and methods of measurement of radio interference characteristics of information technology equipment.

Refer to section 8.3.2 of EN301489-1 for detail.

2.5.2 Limit:

Frequency range	Limit (quasi-peak) (dB μ V)	Limit (average) (dB μ V)
0,15 MHz to 0,5 MHz	66 to 56	56 to 46
> 0,5 MHz to 5 MHz	56	46
> 5 MHz to 30 MHz	60	50

NOTE: The limit decreases linearly with the logarithm of the frequency in the range 0,15 MHz to 0,50 MHz.

2.5.3 Test Procedure:

1. EUT was placed on an 0.8m wooden table above ground plane..
2. Set up EUT with support units and turn on the power of all equipment.
3. Link the EUT with Telecommunication tester, setup the test mode. The transmitter operating at continuously mode and max output rated power.
4. Maximum procedure was performed on the six highest emissions to ensure EUT compliance.
5. Repeat above procedures until all frequency measured were complete.

2.5.4 Test Instruments:

Refer to section 1.7 in this report

2.5.5 Test SET-UP (Block Diagram of Configuration)

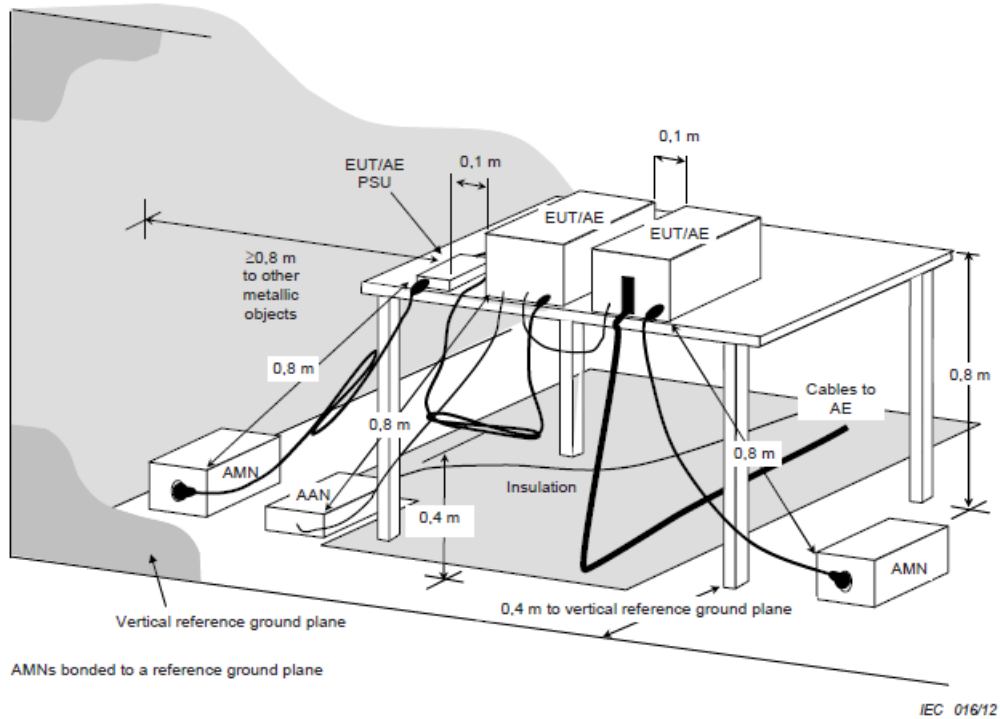

2.5.6 Measurement Result:

N/A,

2.6 AC Mains power input/output ports measurement.

2.6.1 Test Method:

Standard	Date	Description
EN 55032	2015+AC:20 16	Limits and methods of measurement of radio interference characteristics of information technology equipment.

Refer to section 8.4.2 of EN301489-1 And 55032 Annex A for detail. for detail.

2.6.2 Limit: Refer to 2.5.2

2.6.3 Test Procedure: Refer to 2.5.3

2.6.4 Test Instruments: Refer to 2.5.4

2.6.5 Conduction Emission Test Set-up: Refer to 2.5.5

2.6.6 Measurement Result:

Refer to next page for details.

2.6.7 Measurement Data:

Operation Mode:	Config 1	Test Date:	2017/08/14
Test By:	Jason	Pol.:	L1



Address: No. 120, Lane 180, Hsin Ho Rd., Lung-Tan Dist.,
Tao Yuan City 325, Taiwan.
Tel: 03-4071718

Conducted Emission Measurement

operator: Anson J Huang
Temperature: 26 °C
Humidity: 60 %

Date: 2017/8/14

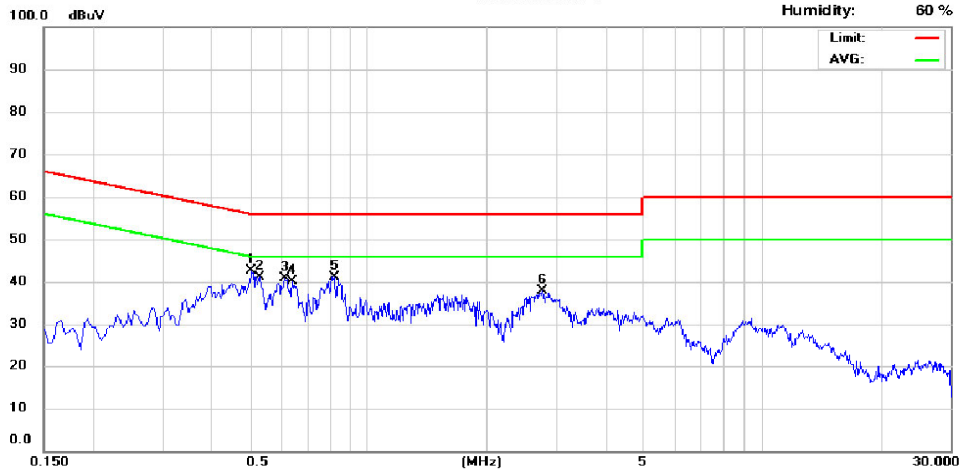

Site: Conduction 03

Phase: L1

No.	Frequency (MHz)	QP_R (dBuV)	AVG_R (dBuV)	Correct Factor (dB)	QP Emission (dBuV)	QP Limit (dBuV)	QP Margin (dB)	AVG Emission (dBuV)	AVG Limit (dBuV)	AVG Margin (dB)
1	0.506	30.89	25.19	9.82	40.71	56.00	-15.29	35.01	46.00	-10.99
2	0.530	30.04	24.48	9.83	39.87	56.00	-16.13	34.31	46.00	-11.69
3	0.614	29.51	23.13	9.83	39.34	56.00	-16.66	32.96	46.00	-13.04
4	0.642	27.63	22.02	9.83	37.46	56.00	-18.54	31.85	46.00	-14.15
5	0.818	28.67	24.60	9.83	38.50	56.00	-17.50	34.43	46.00	-11.57
6	2.770	25.74	19.23	9.91	35.65	56.00	-20.35	29.14	46.00	-16.86

Operation Mode:	Config 1	Test Date:	2017/08/14
Test By:	Jason	Pol.:	N



Address: No. 120, Lane 180, Hsin Ho Rd., Lung-Tan Dist.,
Tao Yuan City 325, Taiwan.
Tel: 03-4071718

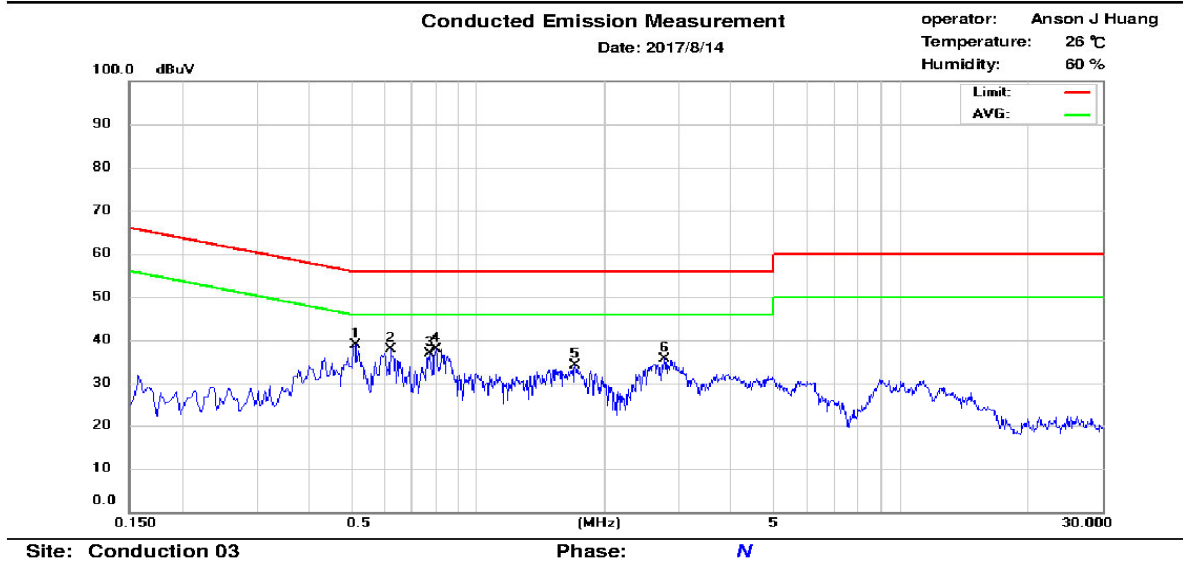

No.	Frequency (MHz)	QP_R (dBuV)	AVG_R (dBuV)	Correct Factor (dB)	QP Emission (dBuV)	QP Limit (dBuV)	QP Margin (dB)	AVG Emission (dBuV)	AVG Limit (dBuV)	AVG Margin (dB)
1	0.514	26.75	20.05	9.84	36.59	56.00	-19.41	29.89	46.00	-16.11
2	0.622	24.97	17.71	9.85	34.82	56.00	-21.18	27.56	46.00	-18.44
3	0.770	23.94	18.56	9.86	33.80	56.00	-22.20	28.42	46.00	-17.58
4	0.798	25.62	20.25	9.86	35.48	56.00	-20.52	30.11	46.00	-15.89
5	1.706	20.64	15.55	9.90	30.54	56.00	-25.46	25.45	46.00	-20.55
6	2.770	23.01	15.45	9.94	32.95	56.00	-23.05	25.39	46.00	-20.61

2.7 Harmonic Current Emissions (AC mains input port) measurement. Refer to EN 301 489-1 Section 8.5

2.7.1 Test Method: Refer to 61000-3-2:2014 and IEC 61000-3-2:2014

2.7.2 Limit

Table 1 – Limits for Class A equipment

Harmonic order n	Maximum permissible harmonic current A
Odd harmonics	
3	2,30
5	1,14
7	0,77
9	0,40
11	0,33
13	0,21
$15 \leq n \leq 39$	$0,15 \frac{15}{n}$
Even harmonics	
2	1,08
4	0,43
6	0,30
$8 \leq n \leq 40$	$0,23 \frac{8}{n}$

Note :For Class B equipment, the harmonics of the input current shall not exceed the values given in table 1 multiplied by a factor of 1,5.

Table 2 – Limits for Class C equipment

Harmonic order n	Maximum permissible harmonic current expressed as a percentage of the input current at the fundamental frequency %
2	2
3	$30 \cdot \lambda^*$
5	10
7	7
9	5
$11 \leq n \leq 39$ (odd harmonics only)	3

* λ is the circuit power factor

Table 3 – Limits for Class D equipment

Harmonic order n	Maximum permissible harmonic current per watt mA/W	Maximum permissible harmonic current A
3	3,4	2,30
5	1,9	1,14
7	1,0	0,77
9	0,5	0,40
11	0,35	0,33
$13 \leq n \leq 39$ (odd harmonics only)	$\frac{3,85}{n}$	See Table 1

2.7.3 Test Procedure:

The EUT was placed on the top of a wooden table 0.8 meters above the ground and operated to produce the maximum harmonic components under normal operating conditions for each successive harmonic component in turn.

2.7.4 Test Instruments:

Refer to section 1.7 in this report

2.7.5 Test Set-up

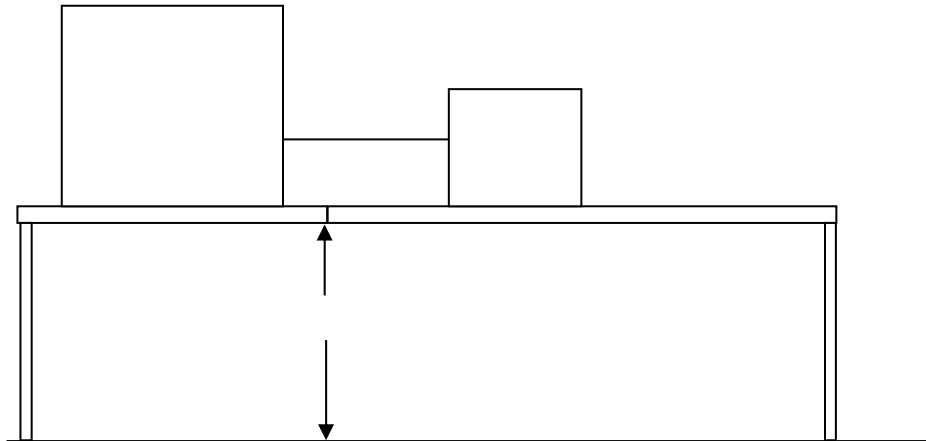

2.7.6 Measurement Result:

N/A

2.8 Voltage Fluctuations and Flicker (AC mains input port) measurement. Refer to EN 301 489-1 Section 8.6

2.8.1 Test Method: Refer to EN 61000-3-3:2013 and IEC 61000-3-3:2013

2.8.2 Limit

TEST ITEM	LIMIT
P_{st}	1.0
P_{lt}	0.65
$D(t)(ms)$	500ms
$d_{max} (%)$	4%
dc (%)	3.3%

2.8.3 Test Procedure:

The EUT was placed on the top of a wooden table 0.8 meters above the ground and operated to produce the most unfavorable sequence of voltage changes under normal operating conditions.

2.8.4 Test Instruments:

Refer to section 1.7 in this report

2.8.5 Test Set-up

Refer to 2.7.5

2.8.6 Measurement Result:

N/A

2.9 Telecommunication Port measurement. Refer to EN 301 489-1 Section 8.7

2.9.1 Test Method:

Standard	Date	Description
EN 55032	2015+AC:20 16	Limits and methods of measurement of radio interference characteristics of information technology equipment.

Refer to section 8.7.2 of EN301489-1 for detail.

2.9.2 Limit: Limits for conducted emissions from telecommunication ports

Frequency range	Voltage limits		Current limits	
	Quasi-peak	Average	Quasi-peak	Average
0.15 MHz to 0.5 MHz	84 dB μ V to 74 dB μ V	74 dB μ V to 64 dB μ V	40 dB μ A to 30 dB μ A	30 dB μ A to 20 dB μ A
0.5 MHz to 30 MHz	74 dB μ V	64 dB μ V	30 dB μ A	20 dB μ A
NOTE 1: The limits decrease linearly with the logarithm of the frequency in the range 0.15 MHz to 0.5 MHz.				
NOTE 2: The current and voltage disturbance limits are derived for use with an Impedance Stabilization Network (ISN) which presents a common mode (asymmetric mode) impedance of 150 Ω to the telecommunication port under test (conversion factor is $20 \log_{10} 150/I = 44\text{dB}$)				
NOTE 3: The emission requirement only applies to telecommunication ports as specified in EN 55022 [7]. The provisional relaxation of 10 dB will be reviewed no later than 3 years after the date of withdrawal based on the results and interference cases seen in this period. Wherever possible it is recommended to comply with the limits without the provisional relaxation.				

2.9.3 Test Procedure: Refer to EN 55032

2.9.4 Test Instruments: Refer to 2.5.4

2.9.5 Conduction Emission Test Set-up: Refer to 2.5.5

2.9.6 Measurement Result:

N/A

3.IMMUNITY

EN 301 489-17

3.1 Test Configuration:

Refer to EN 301 489-1, Section 9.1.

3.2 Special Conditions:

EN301489-17

No special conditions shall apply to UE in the scope of the present document.

3.3 Summary of Test Results:

Test Items	Reference Section	Result
Electrostatic discharge	EN 301 489-1 Section 9.3 EN 55024 Section 4.2.1	PASS
RF electromagnetic field (80MHz to 6000Hz)	EN 301 489-1 Section 9.2 EN 55024 Section 4.2.3.1	PASS
Fast transients, common mode	EN 301 489-1 Section 9.4 EN 55024 Section 4.2.2	N/A
Surges	EN 301 489-1 Section 9.8 EN 55024 Section 4.2.5	N/A
Radio Frequency, common mode	EN 301 489-1 Section 9.5 EN 55024 Section 4.2.3.2	N/A
Voltage Dips and interruptions	EN 301 489-1 Section 9.7	N/A
Transients and surges in the vehicular environment	EN 301 489-1 Section 9.6	N/A

3.4 Performance Criteria Description:

3.4.1 EN301 489-17

The performance criteria are:

- performance criteria A for immunity tests with phenomena of a continuous nature;
- performance criteria B for immunity tests with phenomena of a transient nature;
- performance criteria C for immunity tests with power interruptions exceeding a certain time.

The equipment shall meet the minimum performance criteria as specified in the following table.

Criteria	During test	After test (i.e. as a result of the application of the test)
A	<ul style="list-style-type: none"> • Shall operate as intended. (See note). • Shall be no loss of function. • Shall be no unintentional transmissions. 	<ul style="list-style-type: none"> • Shall operate as intended. • Shall be no degradation of performance. • Shall be no loss of function. • Shall be no loss of critical stored data.
B	<ul style="list-style-type: none"> • May be loss of function. 	<ul style="list-style-type: none"> • Functions shall be self-recoverable. • Shall operate as intended after recovering. • Shall be no loss of critical stored data.
C	<ul style="list-style-type: none"> • May be loss of function. 	<ul style="list-style-type: none"> • Functions shall be recoverable by the operator. • Shall operate as intended after recovering. • Shall be no loss of critical stored data.
NOTE	<p>Operate as intended during the test allows a level of degradation:</p> <p>Minimum performance level:</p> <ul style="list-style-type: none"> • For equipment that supports a PER or FER, the minimum performance level shall be a PER or FER less than or equal to 10 %. • For equipment that does not support a PER or a FER, the minimum performance level shall be no loss of the wireless transmission function needed for the intended use of the equipment. 	

Performance criteria for Continuous phenomena

The performance criteria A shall apply.

Where the EUT is a transmitter in standby mode, unintentional transmission shall not occur during the test.

Performance criteria for Transient phenomena

The performance criteria B shall apply, except for voltage dips greater than or equal to 100 ms and voltage interruptions of 5000 ms duration, for which performance criteria C shall apply.

Where the EUT is a transmitter in standby mode, unintentional transmission shall not occur as a result of the application of the test.

3.5 Electrostatic Discharge Measurement. Refer to EN 301 489-1 Section 9.3

3.5.1 Test Method and Procedure:

EN61000-4-2 and EN 301 489-1 Section 9.3.2.

3.5.2 Performance criteria:

Refer to EN 301 489-1 Section 9.3.3.

Refer to EN 55024 Section 8

3.5.3 Test Instruments:

Refer to section 1.7 in this report

3.5.4 Test SET-UP (Block Diagram of Configuration)

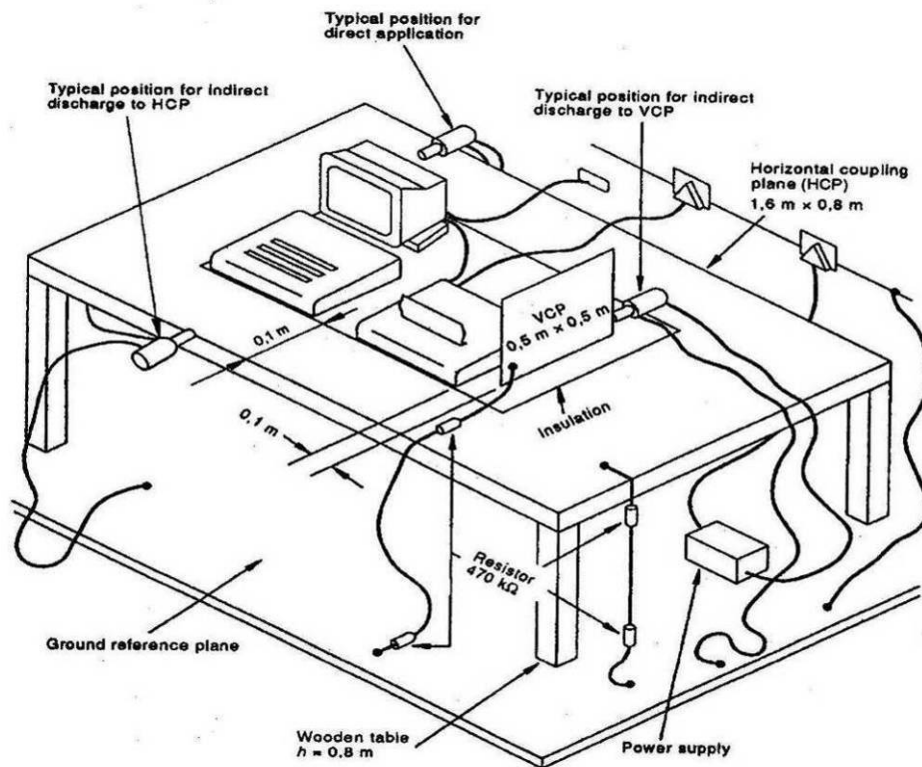

3.5.5 Measurement Result:

Operation Mode:	Config 1, 2	Test Date:	2017/08/15
Temperature:	24 °C	Humidity:	45%
		Test By:	Jason

Basic Standard	: EN61000-4-2
Discharge Impedance	: 330 ohm / 150 pF
Discharge Voltage	: Air Discharge:+/- 2 ~ 8 KV Contact Discharge:+/- 2 ~ 4 KV VCP/HCP:+/- 2 ~ 4 KV
Polarity	: Positive/Negative
Number of Discharge	: Minimum 10/50 times at each test point
Discharge Mode	: Single Discharge
Discharge Period	: 1 second minimum

Note 1:For contact discharge, the EUT shall be exposed to at least 50 discharges, 25 each at negative and positive polarity. For air discharge, A minimum of 10 single air discharges shall be applied

Note 2:Test point refer to test report Appendix 1

Air Discharge							
Test Levels						Results	
±2kV	Performance Criterion	±4kV	Performance Criterion	± 8kV	Performance Criterion	Pass	Fail
<input type="checkbox"/>	<input type="checkbox"/> A <input type="checkbox"/> B <input type="checkbox"/> C	<input type="checkbox"/>	<input type="checkbox"/> A <input type="checkbox"/> B <input type="checkbox"/> C	<input type="checkbox"/>	<input type="checkbox"/> A <input type="checkbox"/> B <input type="checkbox"/> C	<input type="checkbox"/>	<input type="checkbox"/>

Contact Discharge							
Test Levels						Results	
±2kV	Performance Criterion	±4kV	Performance Criterion	± 6kV	Performance Criterion	Pass	Fail
<input checked="" type="checkbox"/>	<input checked="" type="checkbox"/> A <input type="checkbox"/> B <input type="checkbox"/> C	<input checked="" type="checkbox"/>	<input checked="" type="checkbox"/> A <input type="checkbox"/> B <input type="checkbox"/> C	<input type="checkbox"/>	<input type="checkbox"/> A <input type="checkbox"/> B <input type="checkbox"/> C	<input checked="" type="checkbox"/>	<input type="checkbox"/>

Discharge To VCP							
Test Levels						Results	
±2kV	Performance Criterion	±4kV	Performance Criterion	± 6kV	Performance Criterion	Pass	Fail
<input checked="" type="checkbox"/>	<input checked="" type="checkbox"/> A <input type="checkbox"/> B <input type="checkbox"/> C	<input checked="" type="checkbox"/>	<input checked="" type="checkbox"/> A <input type="checkbox"/> B <input type="checkbox"/> C	<input type="checkbox"/>	<input type="checkbox"/> A <input type="checkbox"/> B <input type="checkbox"/> C	<input checked="" type="checkbox"/>	<input type="checkbox"/>

Discharge To HCP							
Test Levels						Results	
±2kV	Performance Criterion	±4kV	Performance Criterion	± 6kV	Performance Criterion	Pass	Fail
<input checked="" type="checkbox"/>	<input checked="" type="checkbox"/> A <input type="checkbox"/> B <input type="checkbox"/> C	<input checked="" type="checkbox"/>	<input checked="" type="checkbox"/> A <input type="checkbox"/> B <input type="checkbox"/> C	<input type="checkbox"/>	<input type="checkbox"/> A <input type="checkbox"/> B <input type="checkbox"/> C	<input checked="" type="checkbox"/>	<input type="checkbox"/>

Remark:

A: No degradation in the performance of the EUT was observed.

3.6 Radio Frequency Electromagnetic Field (80MHz to 6GHz) Measurement. Refer to EN 301 489-1 Section 9.2

3.6.1 Test Method and Procedure:
EN61000-4-3 and EN 301 489-1 Section 9.2.2.

3.6.2 Performance criteria:
Refer to EN 301 489-1 Section 9.2.3.

3.6.3 Test Instruments:
Refer to section 1.7 in this report

3.6.4 Test SET-UP (Block Diagram of Configuration):
Test setup:

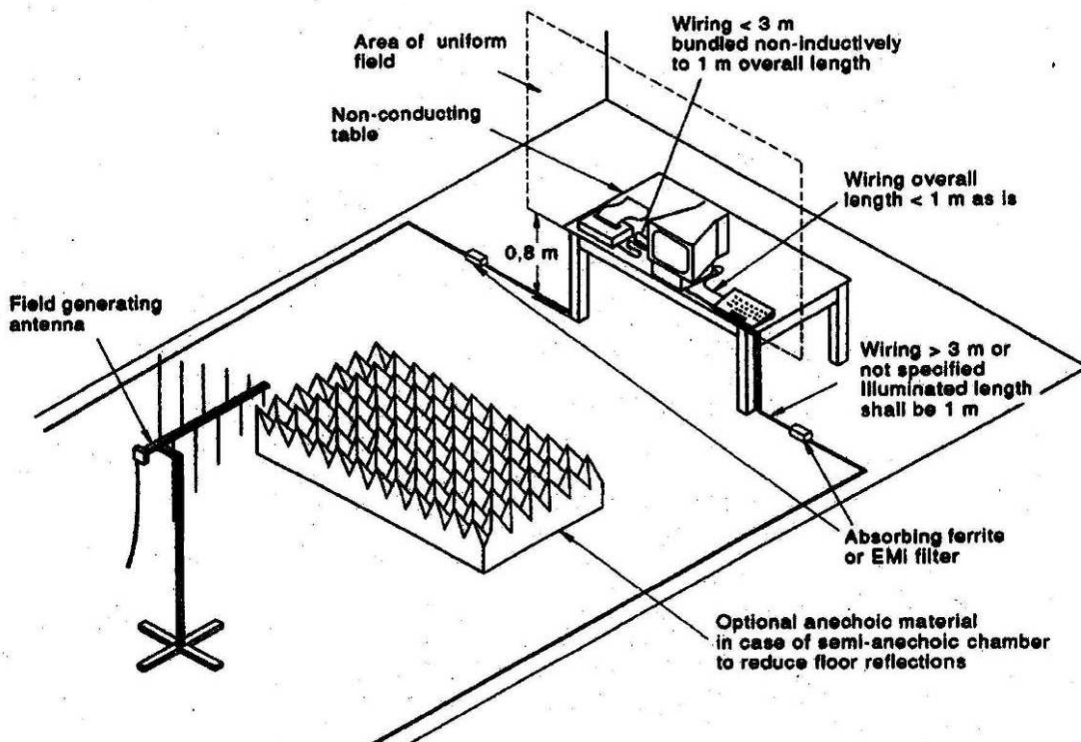

3.6.5 Measurement Result:
Refer to below for results.

3.6.6 Measurement Data:

Operation Mode:	Config 1,2	Test Date:	2017/08/21
Temperature:	25 °C	Humidity:	51 %
		Test By:	Jason

Basic Standard : EN61000-4-3
 Frequency range : 80 to 6000MHz
 Field strength : 3 V/m
 Modulation : AM 80%, 1 kHz Sinewave
 Frequency step : 1 % of fundamental
 Polarity of Antenna : Horizontal and Vertical
 Test distance : 3 m (EUT to antenna reference point)

No.	Frequency (MHz)	Antenna Orientation	Observation	EUT Orientation
1	80 - 6000	Vertical/Horizontal	CT, CR and A, the EUT to be continuously received with no timeouts	0 degree
2	80 - 6000	Vertical/Horizontal		90 degree
3	80 - 6000	Vertical/Horizontal		180 degree
4	80 - 6000	Vertical/Horizontal		270 degree

Remark:

A : No degradation in the performance of the EUT was observed.
 N/A : Not Applicable.

3.7 Fast Transients, Common Mode Measurement. Refer to EN 301 489-1 Section 9.4

3.7.1 Test Method and Procedure:

EN61000-4-4: 2012, and EN 301 489-1 Section 9.4.2.

3.7.2 Performance criteria:

Refer to EN 301 489-1 Section 9.4.3.

3.7.3 Test Instruments

Refer to section 1.7 in this report

3.7.4 Test SET-UP (Block Diagram of Configuration):

Refer to Appendix 2 setup photo

3.7.5 Measurement Result:

N/A

3.8 Surges Measurement. Refer to EN 301 489-1 Section 9.8

3.8.1 Test Method and Procedure:

EN61000-4-5: 2014, and EN 301 489-1 Section 9.8.2.

3.8.2 Performance criteria:

Refer to EN 301 489-1 Section 9.8.3.

Refer to EN 55024 Section 8

3.8.3 Test Instruments:

Refer to section 1.7 in this report

3.8.4 Test SET-UP (Block Diagram of Configuration):

Refer to Appendix 2 setup photo

3.8.5 Measurement Result:

N/A

3.9 Radio Frequency, Common Mode Measurement. Refer to EN 301 489-1 Section 9.5

3.9.1 Test Method and Procedure:

EN61000-4-6: 2014+AC:2015, and EN 301 489-1 Section 9.5.2.

3.9.2 Performance criteria:

Refer to EN 301 489-1 Section 9.5.3.

3.9.3 Test Instruments:

Refer to section 1.7 in this report

3.9.4 Test SET-UP (Block Diagram of Configuration):

Refer to Appendix 2 setup photo

3.9.5 Measurement Result:

N/A

3.10 Transients and surges in the vehicular environment measurement. Refer to EN 301 489-1 Section 9.6

3.10.1 Test Method and Procedure:

Refer to ISO 7637-2 for 12Vdc and 24Vdc equipment. , and EN 301 489-1 Section 9.6.2.

3.10.2 Performance criteria:

Refer to EN 301 489-1 Section 9.6.3.

3.10.3 Test Instruments:

Refer to section 1.7 in this report

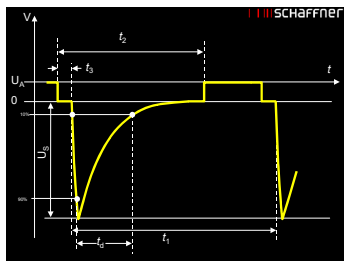
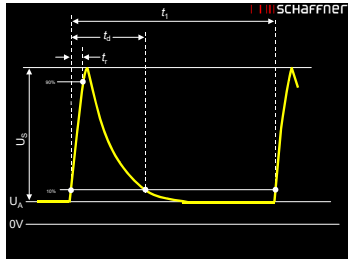
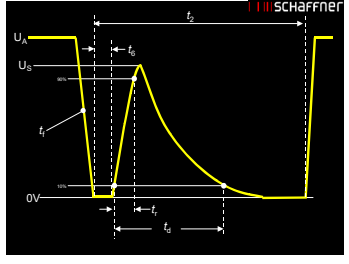
Pulse	Us/Vs	Ri	Test parameters	Delay	Figure
ISO 7637-2 (2004) – Pulse 1	-450V	50.0 Ohm	td = 1.0ms, t1 = 2.5s, t2 = 200.0m	0.0 s	
ISO 7637-2 (2004) – Pulse 2A	37.5V	2.0 Ohm	td = 50.0us, t1 = 3.0s	0.0 s	
ISO 7637-2 (2004) – Pulse 2B	20.0V	0.0 Ohm	td = 1.0s	60.0 s	

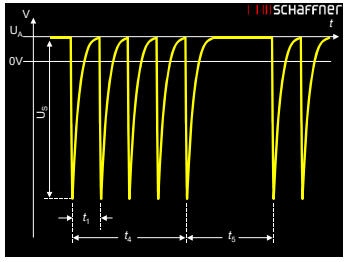
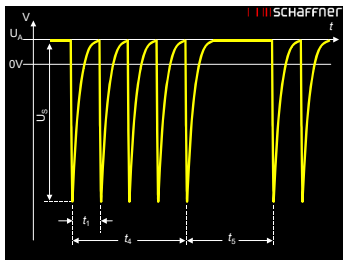
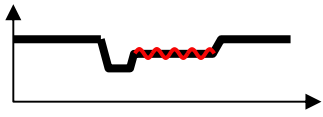
ISO 7637-2 (2004) – Pulse 3A	-150V	50.0 Ohm	t1 = 100.0us, t4 = 10.0ms, t5 = 90.0ms	0.0 s	
ISO 7637-2 (2004) – Pulse 3B	150V	50.0 Ohm	t1 = 100.0us, t4 = 10.0ms, t5 = 90.0ms	0.0 s	
ISO 7637-2 (2004) – Pulse 4	-12V	0.0 Ohm	Ua = -5.0V, t7 = 70.0ms, t8 = 30.0ms, t9 = 10.0s, t10 = 10.0ms, t11 = 50.0ms	60.0 s	

3.10.4 Test SET-UP (Block Diagram of Configuration):

Refer to Appendix 2 setup photo.

3.10.5 Measurement Result:

N/A.

3.11 Voltage Dips and Interruptions Measurement. Refer to EN 301 489-1 Section 9.7

3.11.1 Test Method and Procedure:

EN61000-4-11: 2004, and EN 301 489-1 Section 9.7.2.

3.11.2 Performance criteria:

Refer to EN 301 489-1 Section 9.7.3.

Refer to EN 55024 Section 8

3.11.3 Test Instruments

Refer to section 1.7 in this report

3.11.4 Test SET-UP:

Refer to Appendix 2 setup photo

3.11.5 Measurement Result:

N/A

APPENDIX 1

ESD TEST POINT

Photo 1

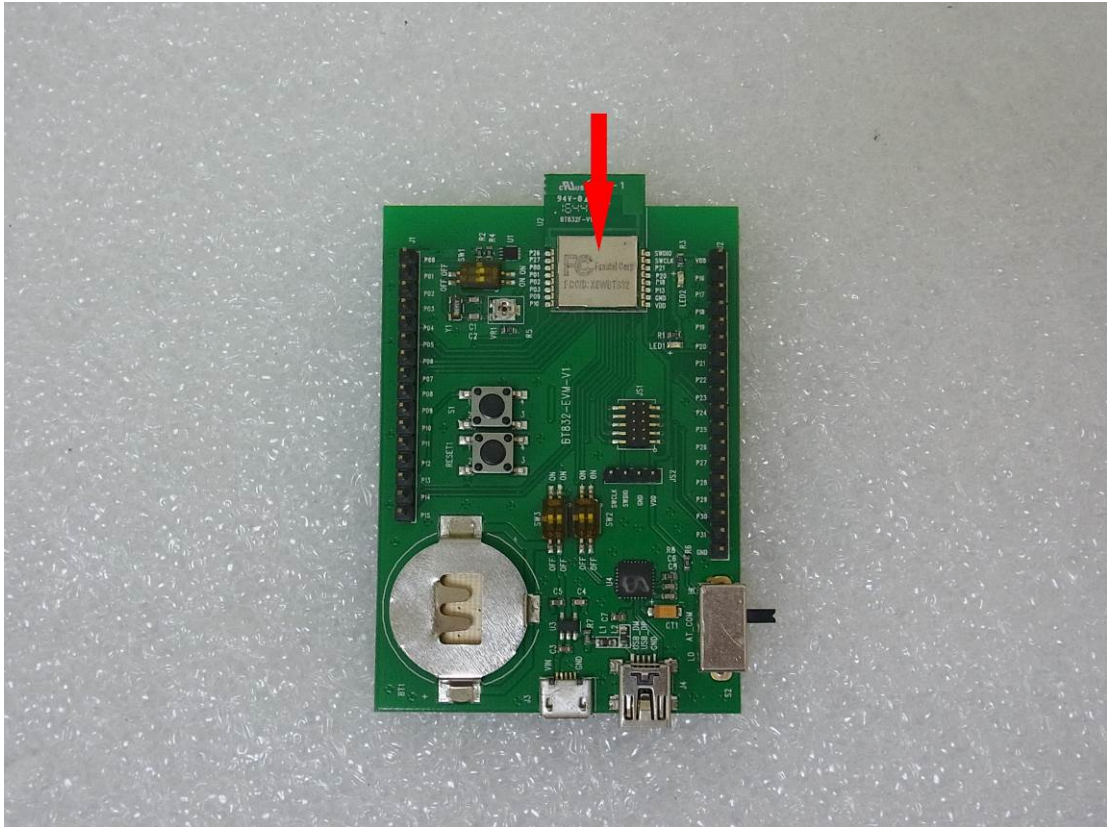
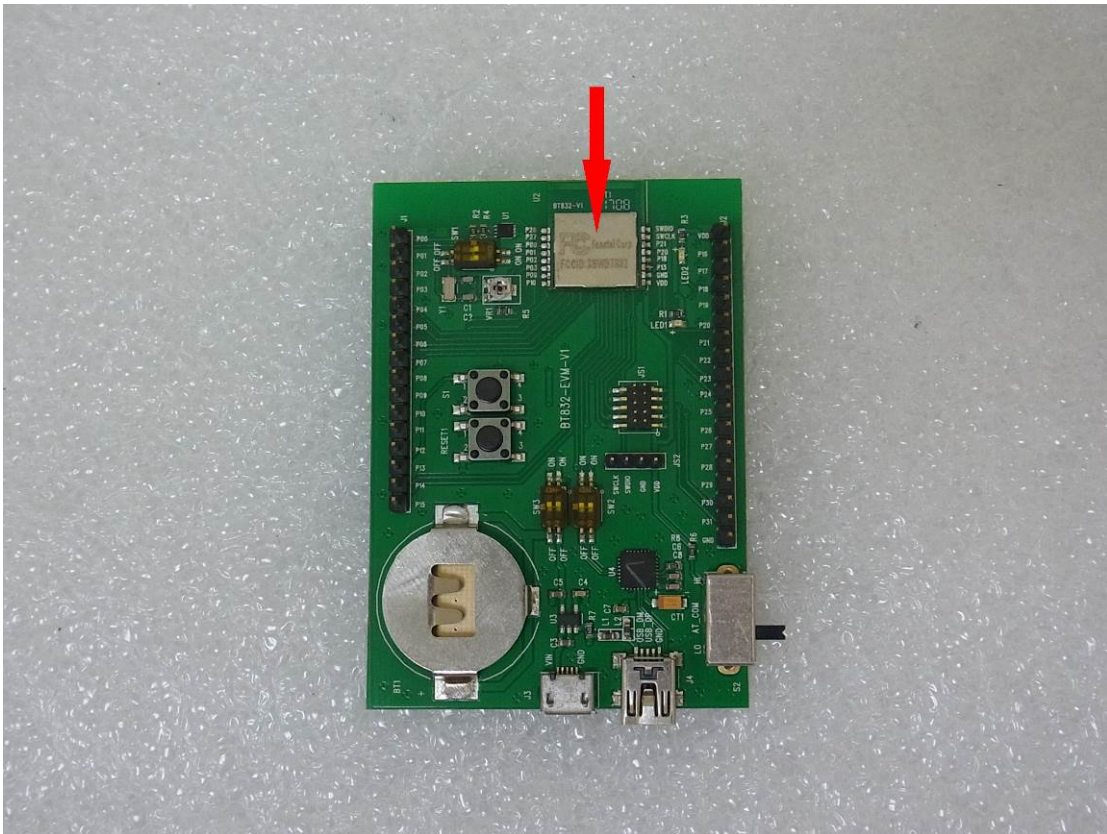

Photo 2



APPENDIX 2

PHOTOGRAPHS OF TEST SETUP

RADIATED EMISSION TEST (Config 1)

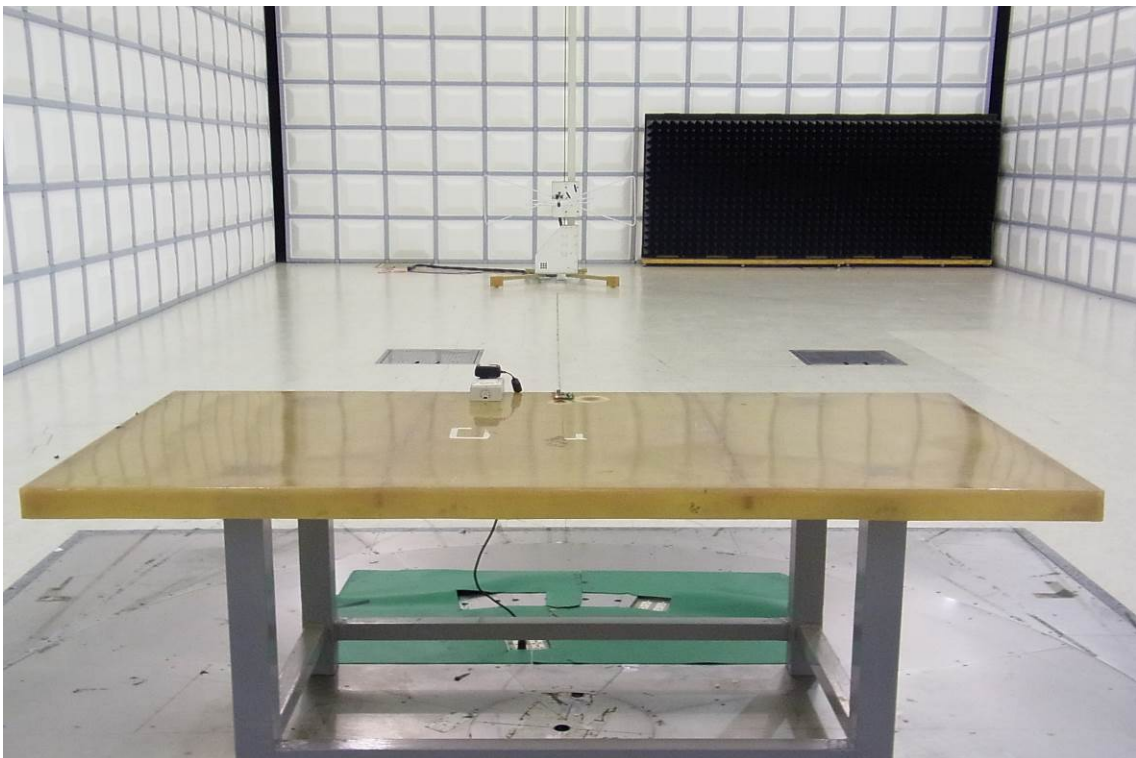
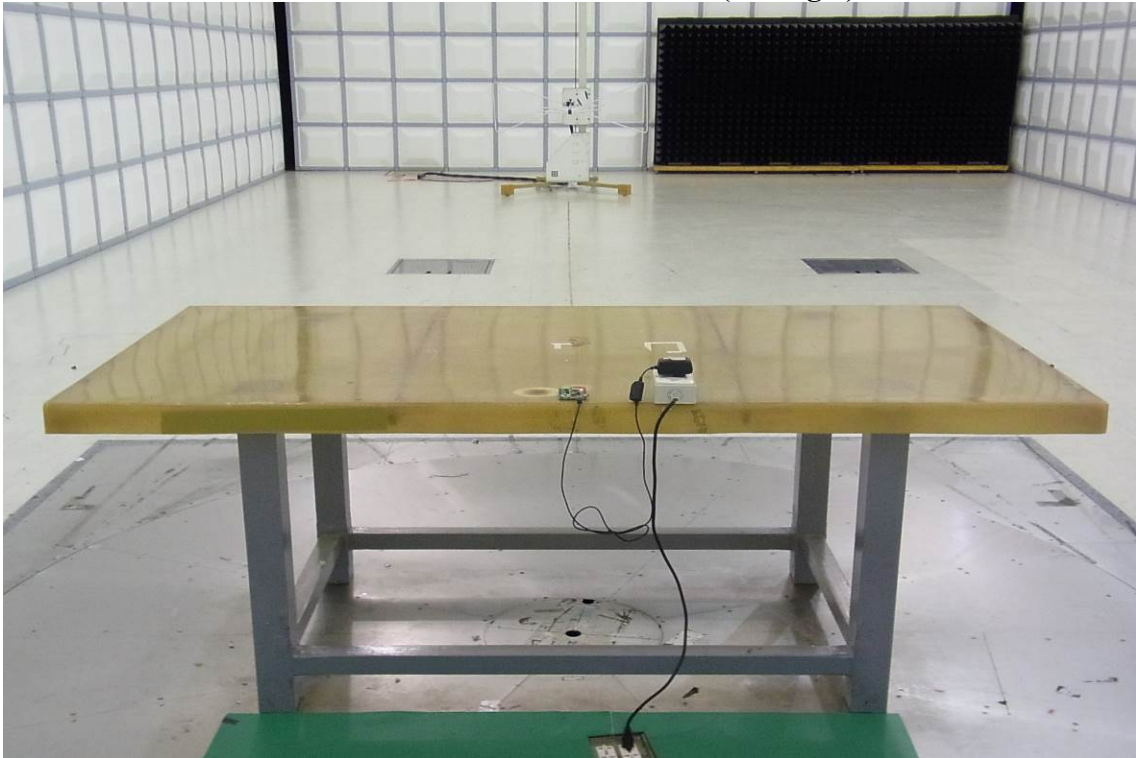



AC POWER LINE CONDUCTED EMISSION TEST (Config 1)

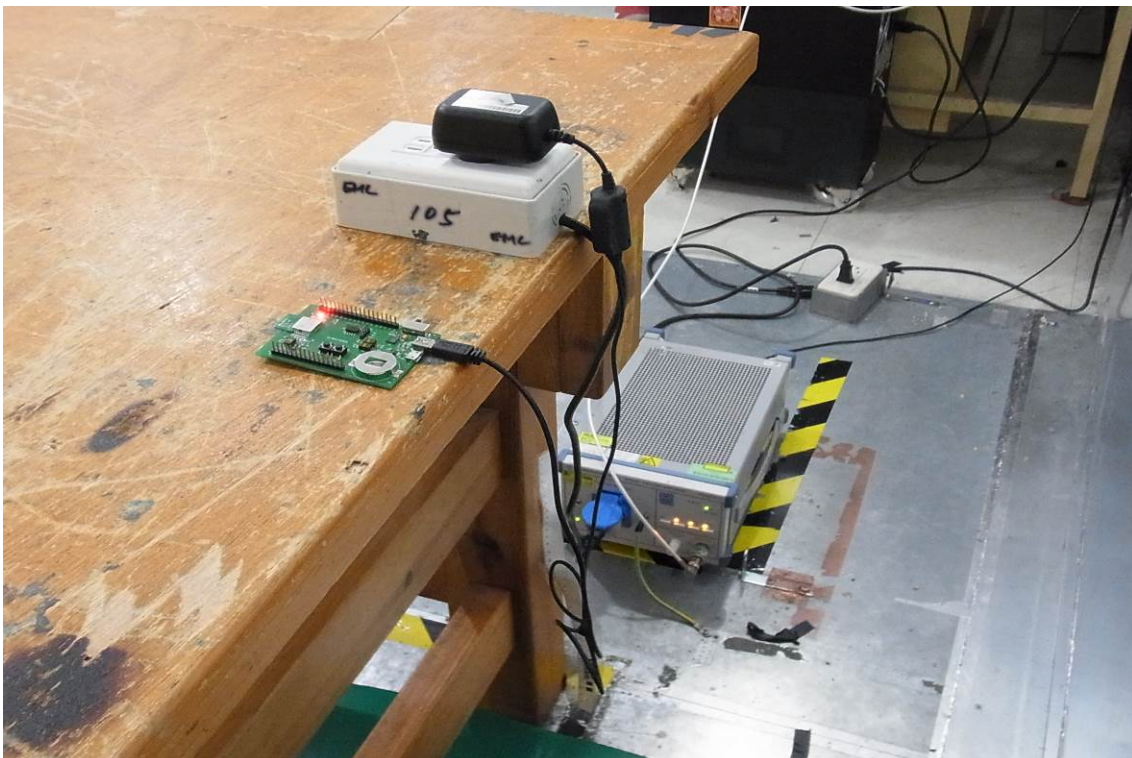
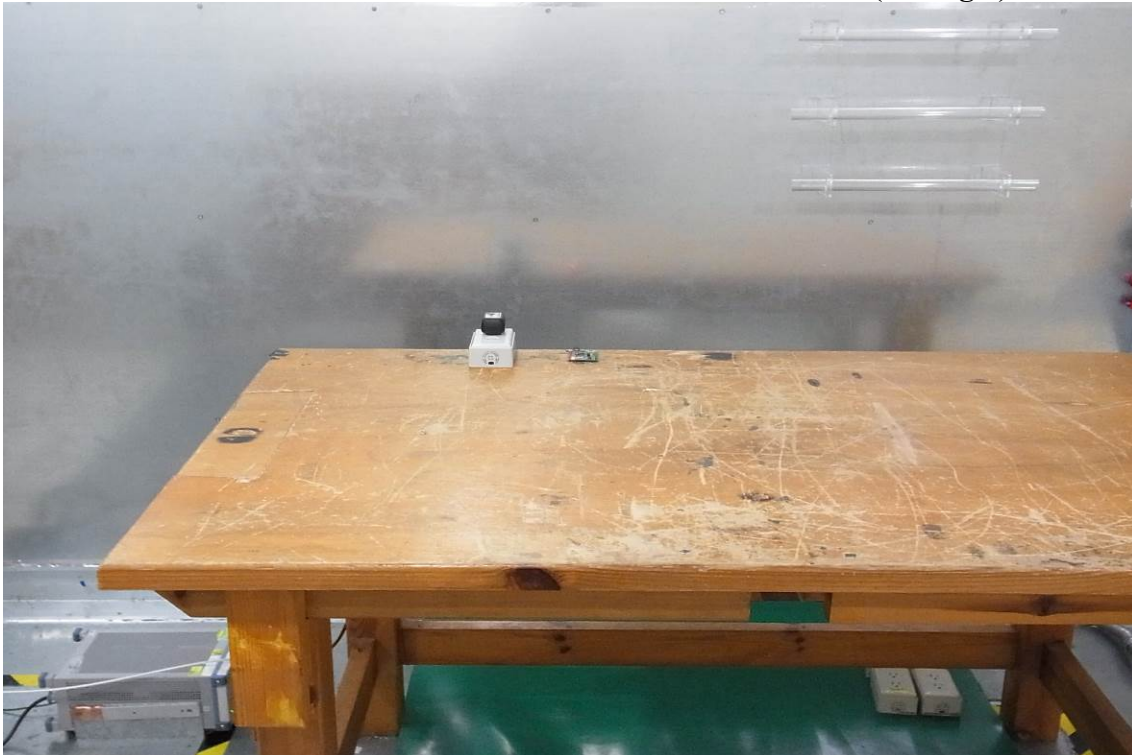

ELECTROSTATIC DISCHARGE TEST (EN 61000-4-2) (Config 1)



ELECTROSTATIC DISCHARGE TEST (EN 61000-4-2) (Config 2)

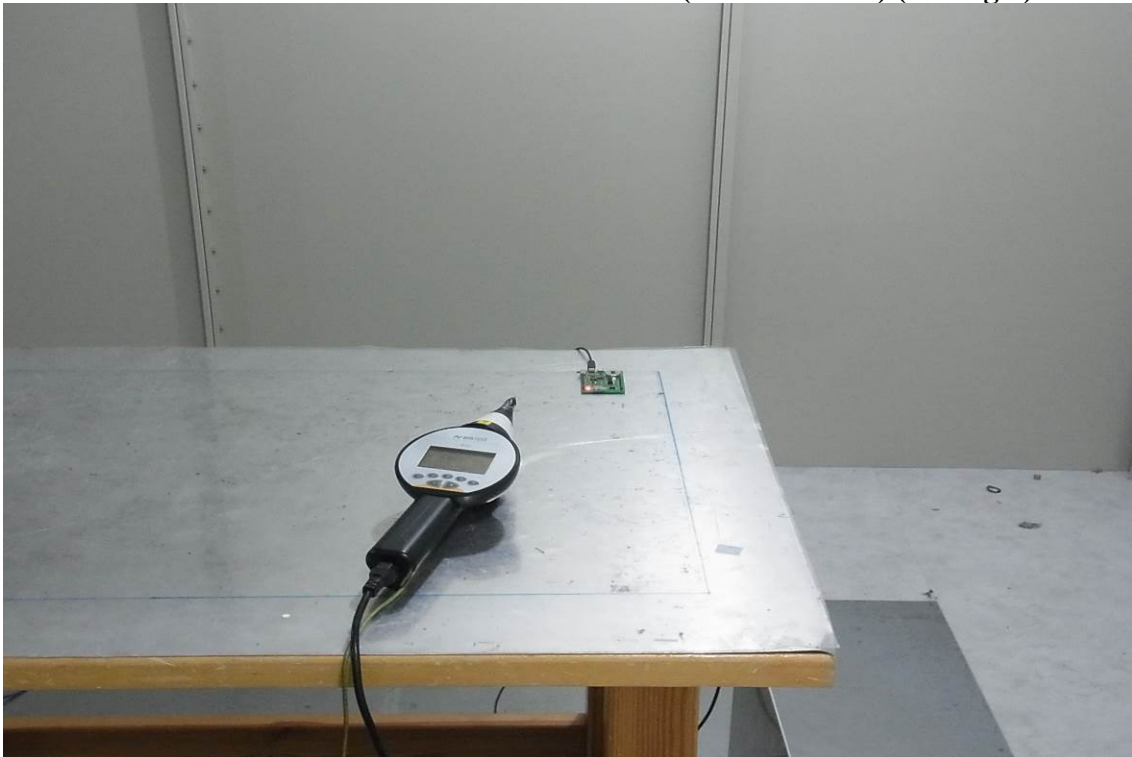

RADIATED ELECTROMAGNETIC FIELD (EN 61000-4-3) (Config 1)



RADIATED ELECTROMAGNETIC FIELD (EN 61000-4-3) (Config 2)



APPENDIX 3

PHOTOGRAPHS OF EUT

EUT 1 Model: BT832

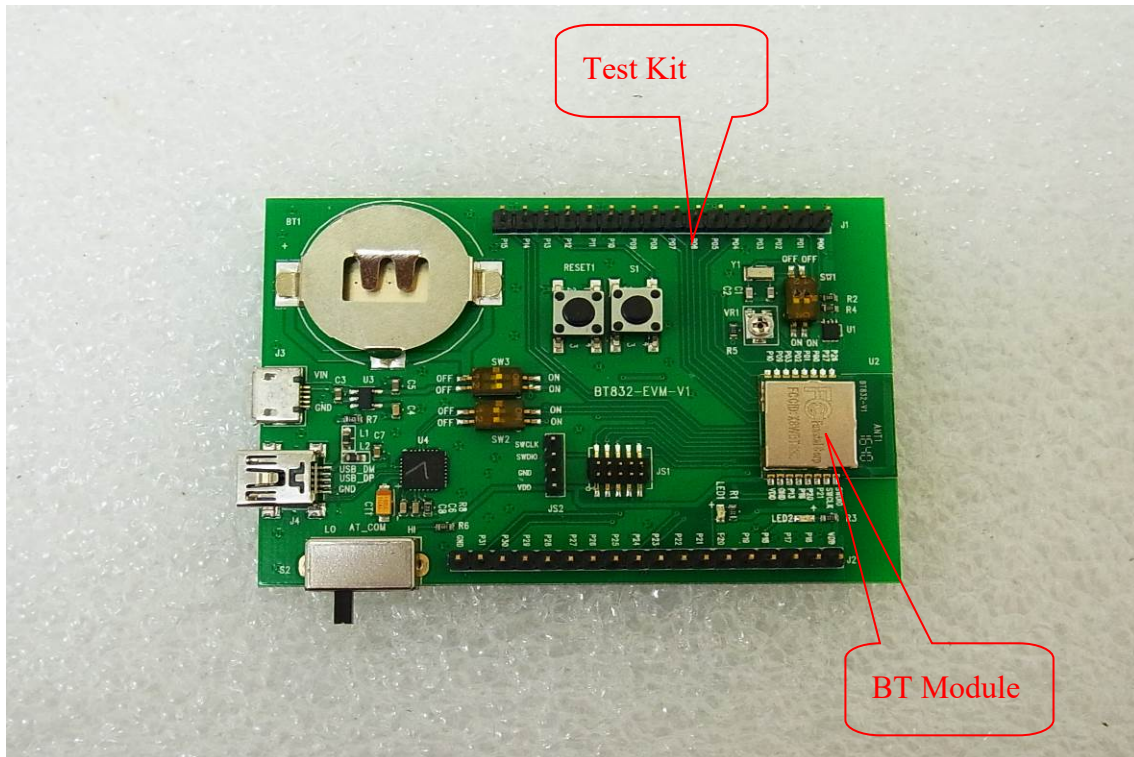

EUT 2 Model: BT832F

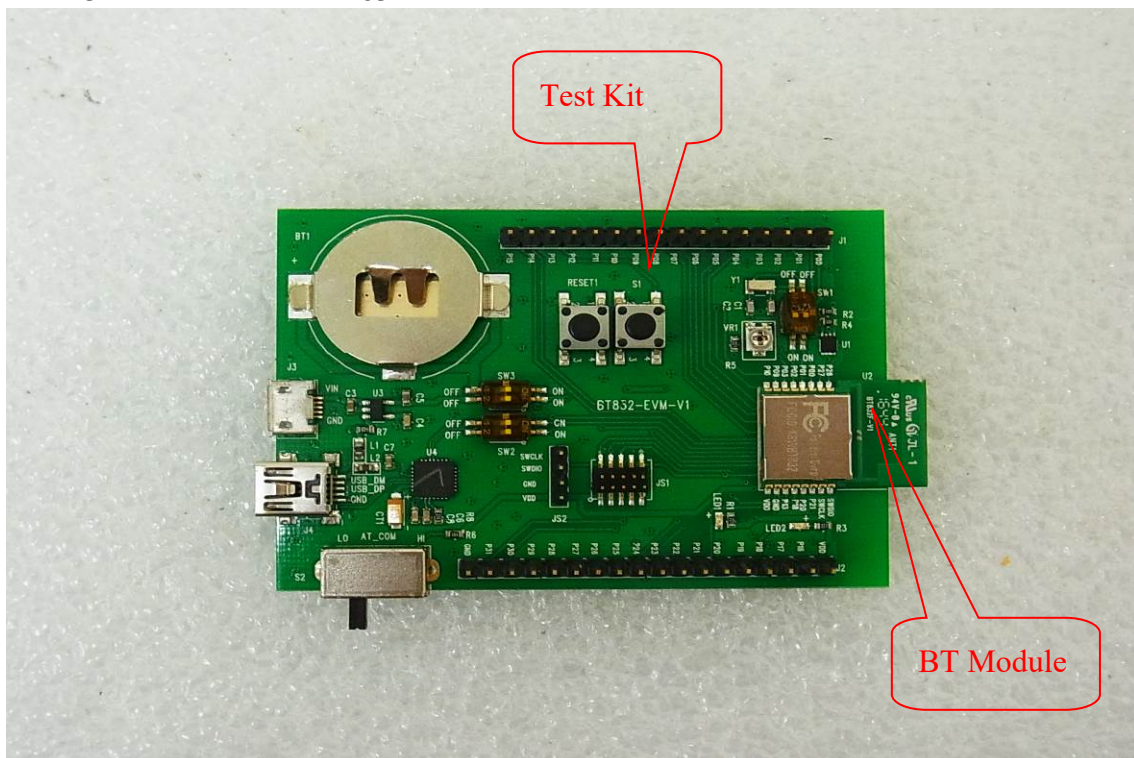

EUT 3 Model: BT832

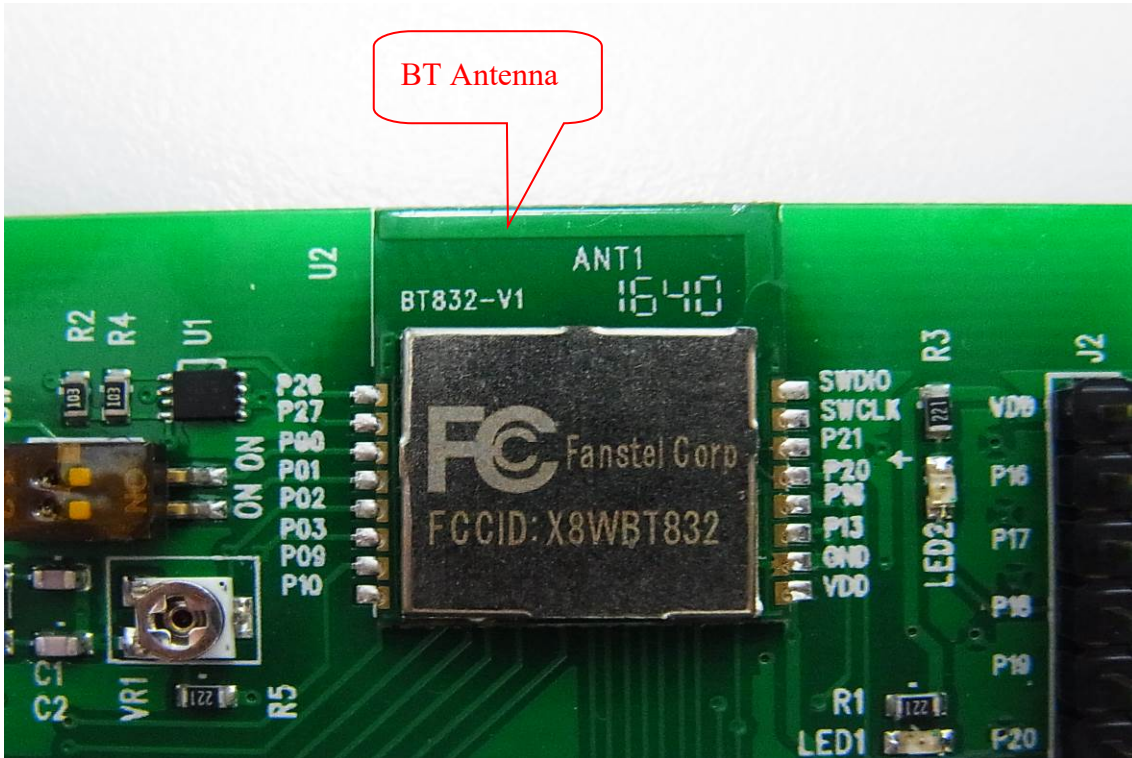

EUT 4 Model: BT832



EUT 5 Model: BT832F

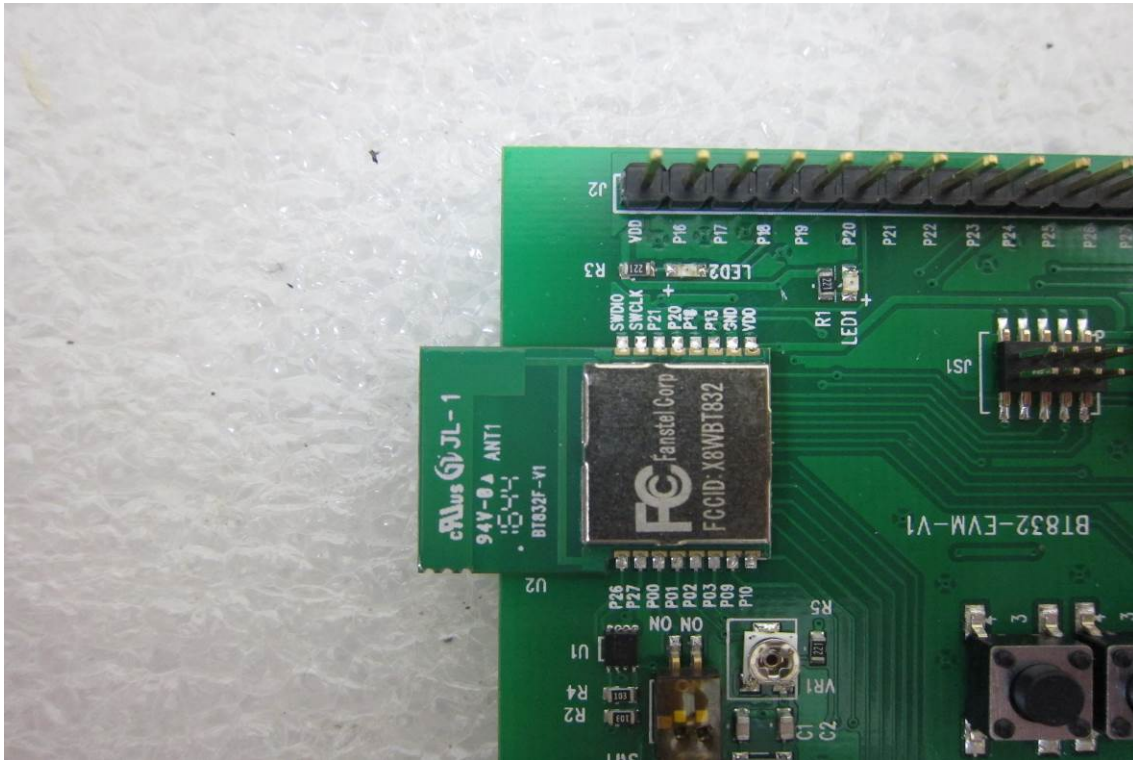

EUT 6 Model: BT832F



EUT 7 Model: BT832F

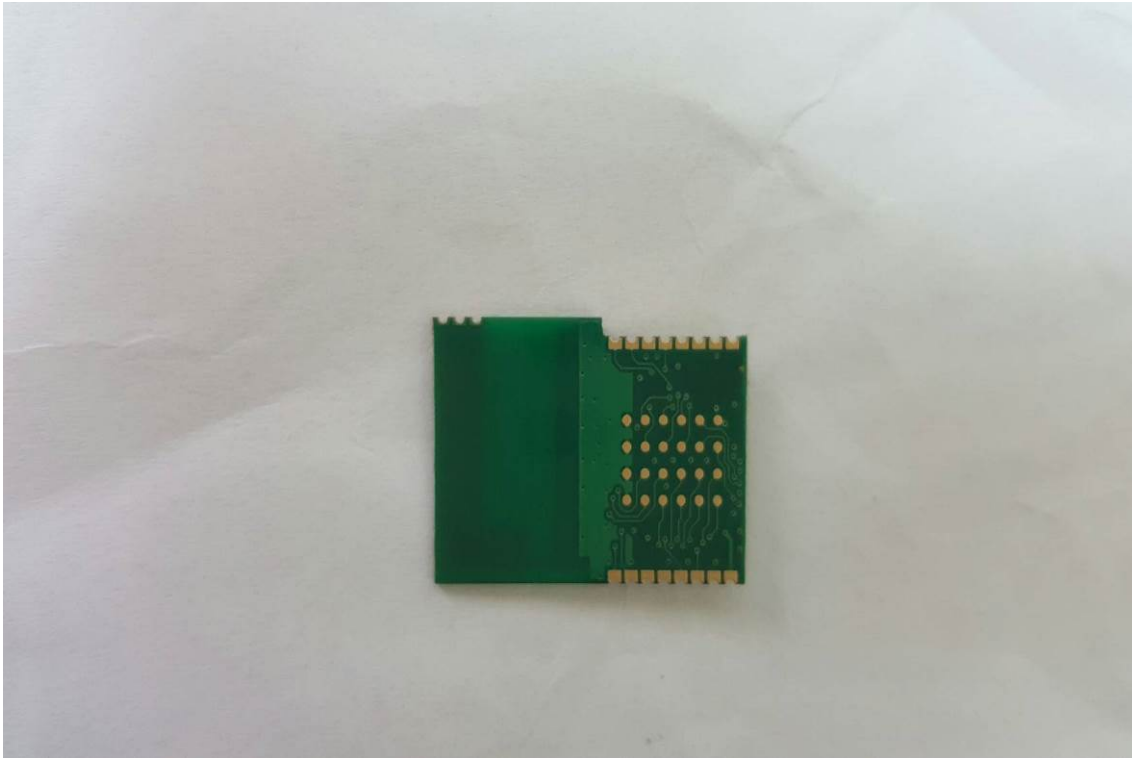

EUT 8 Model: BT832A



EUT 9 Model: BT832A

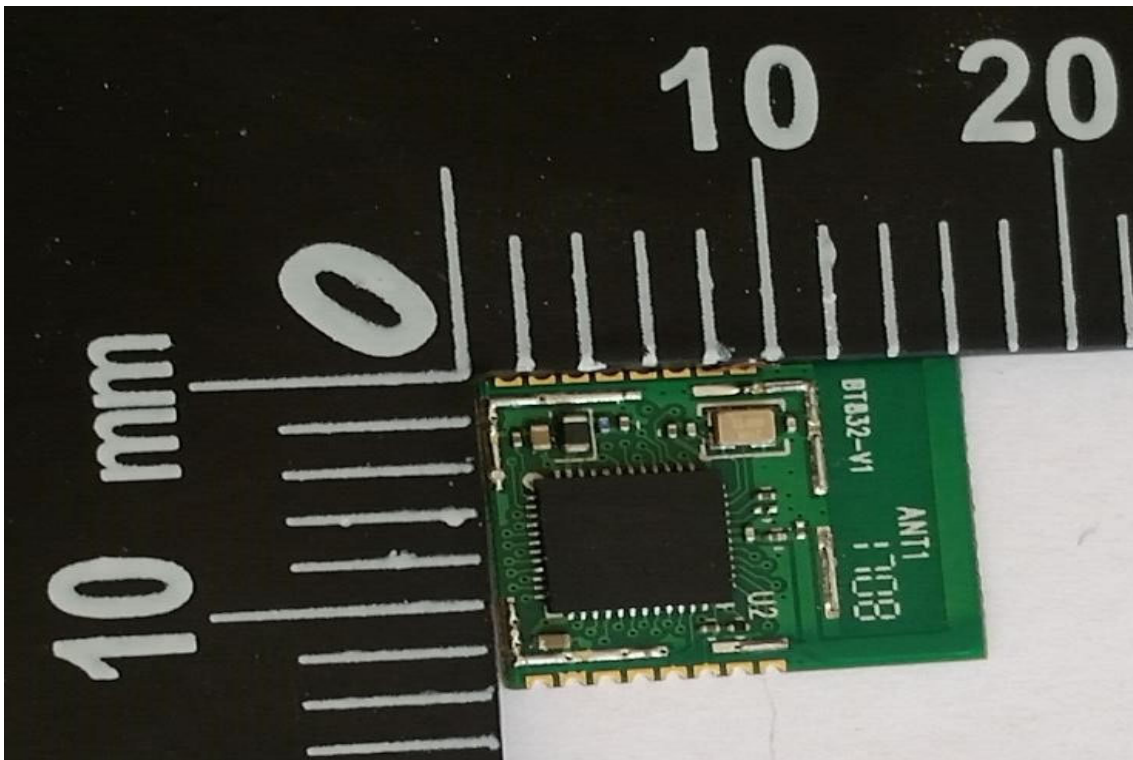

EUT 10 Model: BT832A

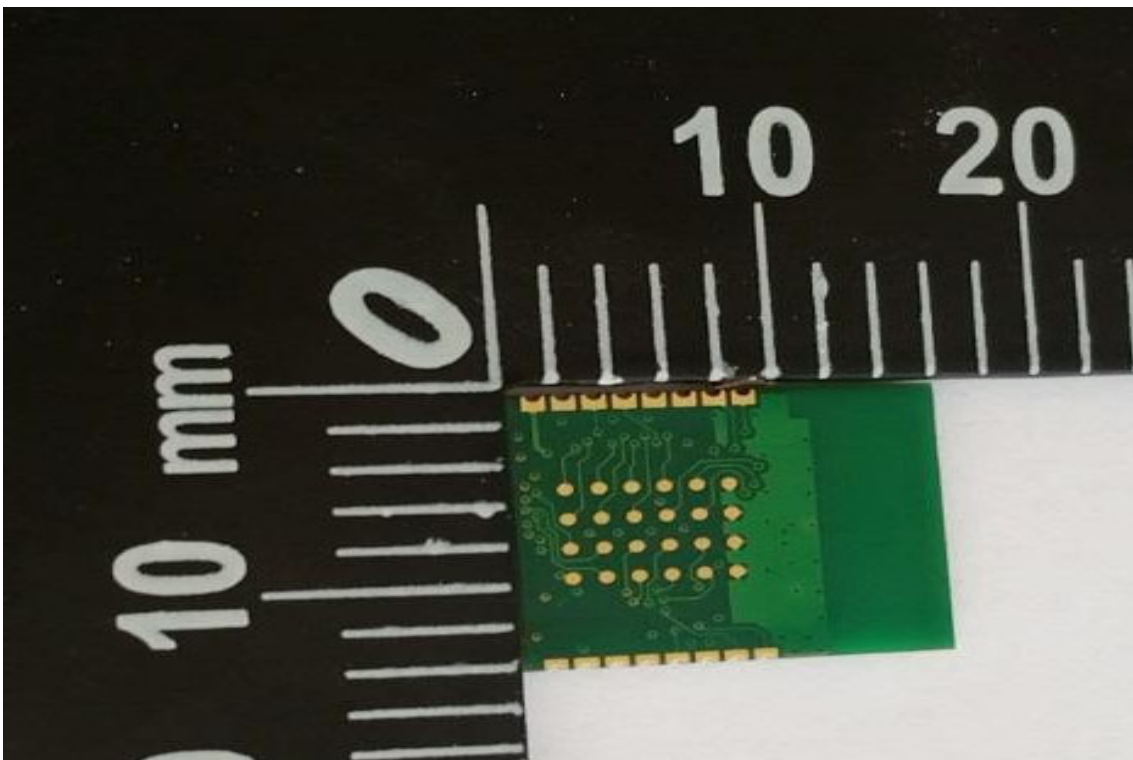

EUT 11 Model: BT832AF



EUT 12 Model: BT832AF

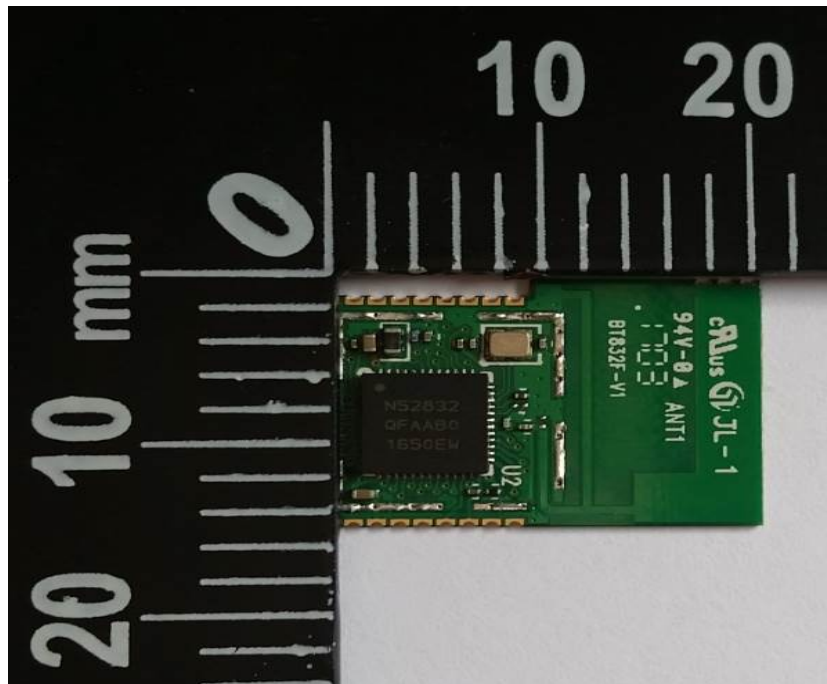

EUT 13 Model: BT832AF

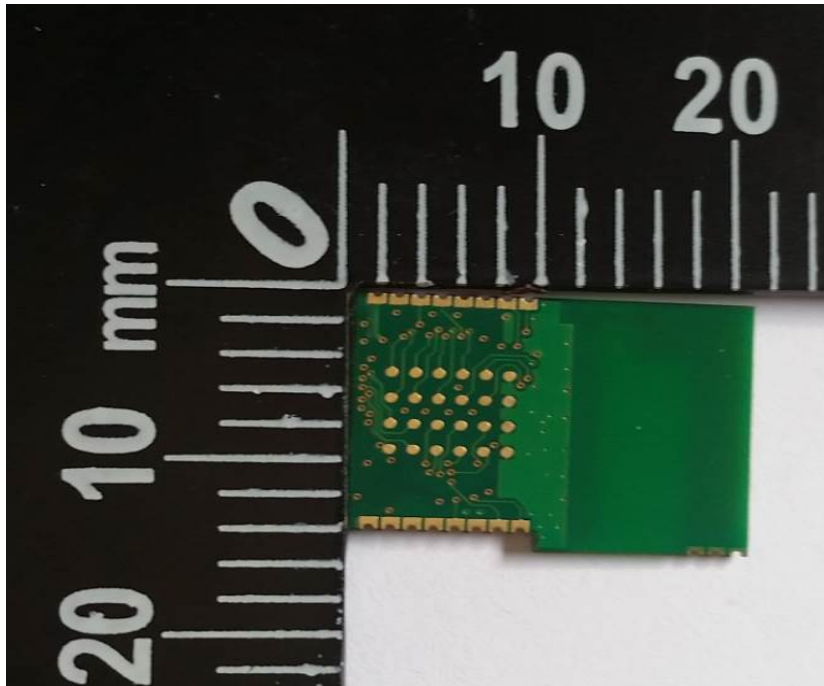

~ End of Report ~