

PARTIAL TEST REPORT

of

RE Directive (2014/53/EU)

ETSI EN 300 328 v2.2.2

Product: ESP32 WROOM-32 module

Brand: Fanstel

Model: ESP32M4; ESP32E4; ESP32M16;
ESP32E16; ESP32F16; ESP32F4

Model Difference: Memory, Antenna . Please see page 5 for detail

Applicant: Fanstel Corporation, Taipei

Address: 10F-10, No. 79, Sec. 1, Hsin Tai Wu Rd.,
Hsi-Chih, New Taipei City 221 Taiwan

Test Performed by:



International Standards Laboratory Corp. LT Lab.

TEL: +886-3-263-8888 FAX: +886-3-263-8899

No. 120, Lane 180, Hsin Ho Rd., Lung-Tan Dist., Tao Yuan City 325,
Taiwan

Report No.: **ISL-20LR045E328-R1**
Issue Date : **2021/03/30**



Test results given in this report apply only to the specific sample(s) tested and are traceable to national or international standard through calibration of the equipment and evaluating measurement uncertainty herein.

The uncertainty of the measurement does not include in consideration of the test result unless the customer required the determination of uncertainty via the agreement, regulation or standard document specification.

This test report shall not be reproduced except in full, without the written approval of International Standards Laboratory Corp.

VERIFICATION OF COMPLIANCE

Applicant: Fanstel Corporation, Taipei
Equipment Under Test: ESP32 WROOM-32 module
Brand Name: Fanstel
Model Number: ESP32M4; ESP32E4; ESP32M16; ESP32E16; ESP32F16; ESP32F4
Model Different: Memory , Antenna. Please see page 5 for detail
Date of Test: 2021/02/20 ~ 2021/02/27
Date of EUT Received: 2021/02/18

APPLICABLE STANDARDS
ETSI EN 300 328 V2.2.2
This report only covers partial test item, including EIRP, Tx RSE, and Receiver Blocking

The above equipment was tested by International Standards Laboratory Corp. for compliance with the requirements set forth in the European Standard ETSI EN 300328 V V2.2.2. under article 3.2 of RE Directive 2014/53/EU. The results of testing in this report apply to the product/system that was tested only. Other similar equipment will not necessarily produce the same results due to production tolerance and measurement uncertainties.

<i>Test By:</i>		<i>Date:</i>	2021/03/30
	<i>Weitin Chen / Senior Engineer</i>		
<i>Prepared By:</i>		<i>Date:</i>	2021/03/30
	<i>Elisa Chen / Senior Engineer</i>		
<i>Approved By:</i>		<i>Date:</i>	2021/03/30
	<i>Jerry Liu / Assistant Manager</i>		

Version

Version No.	Date	Description
00	2021/03/30	Initial creation of document

TABLE OF CONTENTS

1. Description of Equipment under Test (EUT).....	5
2. Description of Test Modes.....	7
3. General Description of Applied Standards.....	8
4. Test Facility	8
5. Block Diagram of Test Setup	9
6. RF Output Power	15
7. Transmitter Unwanted Emissions in the Spurious Domain	20
8. Receiver Blocking.....	23
PHOTOGRAPHS OF SET UP	30
PHOTOGRAPHS OF EUT	34

1. Description of Equipment under Test (EUT)

General:

Product Name:	ESP32 WROOM-32 module
Brand Name:	Fanstel
Model Name:	ESP32M4; ESP32E4; ESP32M16; ESP32E16; ESP32F16; ESP32F4
Model Difference:	Antenna. Please see table below for detail.
Type of Equipment:	Stand-alone equipment
Temperature Range:	-40°C to + 105°C
Simultaneous transmissions:	Yes
Geo-location capability:	No
Power Supply	5Vdc by USB port

Model Summaries

module	ESP32M4	ESP32F4.	ESP32E4.	ESP32M16	ESP32F16	ESP32E16.
SoC	ESP32-D0WD	ESP32-D0WD	ESP32-D0WD	ESP32-D0WD	ESP-D0WD	ESP32-D0WD
Flash memory	4MB, IS25LP032-JBLE	4MB, IS25LP032-JBLE	4MB, IS25LP032-JBLE	16MB, IS25LP128-JBLE	16MB, IS25LP128-JBLE	16MB, IS25LP128-JBLE
Size	18x25.5	18x25.5	18x25.5	18x25.5	20x29.5	18x25.5
WIFI Antenna	PCB trace	PCB trace	u.FL	PCB trace	PCB trace	u.FL
Max TX						
Operating temp.	-40°C to +105°C	-40°C to +105°C	-40°C to +105°C	-40°C to +105°C	-40°C to +105°C	-40°C to +105°C
Price at 1K pcs	\$3.46			\$4.33		\$4.49
Availability				Sample 03/2020		Sample 03/2020

2.4GHz WLAN: 1TX/1RX SISO

Frequency Range:	2412MHz–2472MHz
Channel number:	802.11b/g: 13channels 802.11n_HT20: 13 channels 802.11n_HT40: 11 channels
Transmit Power (EIRP):	802.11b:17.92dBm 802.11g:19.82 dBm 802.11n_HT20:19.92 dBm 802.11n_HT40:19.92 dBm
Modulation Technology:	DSSS, OFDM
Antenna Designation:	PCB Antenna ESP32M : 2.22 dBi ESP32F: 1.70 dBi Dipole Antenna ESP32E : 0dBi
Modulation type:	CCK, DQPSK, DBPSK for DSSS 256QAM.64QAM. 16QAM, QPSK, BPSK for OFDM
TPC feature:	No
DFS operation mode:	N/A
Ad-hoc mode:	No.
Occupied Channel Bandwidth:	Within 2400-2483.5MHz,
Duty Cycle:	N/A
Adaptive/ Non-Adaptive:	Adaptive
LBT based Detect and Avoid:	Load Based Equipment
Antenna Beamforming:	No

The EUT is compliance with IEEE 802.11 b/g/n Standard.
This test report applies for WLAN 802.11b/g/n.

2. Description of Test Modes

The EUT has been tested under Operating condition. To control the EUT for staying in continuous transmitting and receiving mode is programmed.

802.11 b: Lowest (2412MHz), Mid (2437MHz) and Highest (2472MHz) with 1 Mbps

802.11 g: Lowest (2412MHz), Mid (2437MHz) and Highest (2472MHz) with 6 Mbps

802.11n HT20: Lowest (2412MHz), Mid (2437MHz) and Highest (2472MHz) with 6.5Mbps

802.11n HT40: Lowest (2422MHz), Mid (2437MHz) and Highest (2462MHz) with 13.5Mbps

The worst case of Radiated Spurious Emission was report:

1. 802.11n HT20: Lowest (2412MHz), Mid (2437MHz) and Highest (2472MHz)

Normal test conditions :

Refer to section 5.1.1.2 of EN 300 328

Temperature : -20°C to + 70°C

Relative humidity: 20 % to 75 %

Normal Voltage: 5Vdc

Extreme test conditions :

Refer to section 5.1.1.3 of EN 300 328

Where tests at extreme temperatures are required, measurements shall be made over the extremes of the operating temperature range as declared by the manufacturer.

Extreme temperatures: -40°C to + 105°C

3. General Description of Applied Standards

The EUT According to the Specifications, it must comply with the requirements of the following standards:

ETSI EN 300 328 V2.2.2 – Wideband transmission systems; Data transmission equipment operating in the 2,4 GHz ISM band; Harmonized Standard for access to radio spectrum

4. Test Facility

International Standards Laboratory Corp.

<LT Lab.>

No. 120, Lane 180, Hsin Ho Rd., Lung-Tan Dist., Tao Yuan City 325, Taiwan

A fully anechoic chamber was used for the radiated spurious emissions test.

TAF Accreditation Lab. Lab number: 0997

5. Block Diagram of Test Setup

5.1 EUT Configuration

Fig. 1 Configuration of Tested System

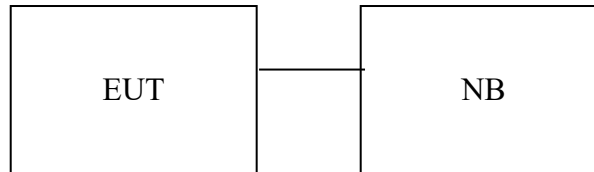
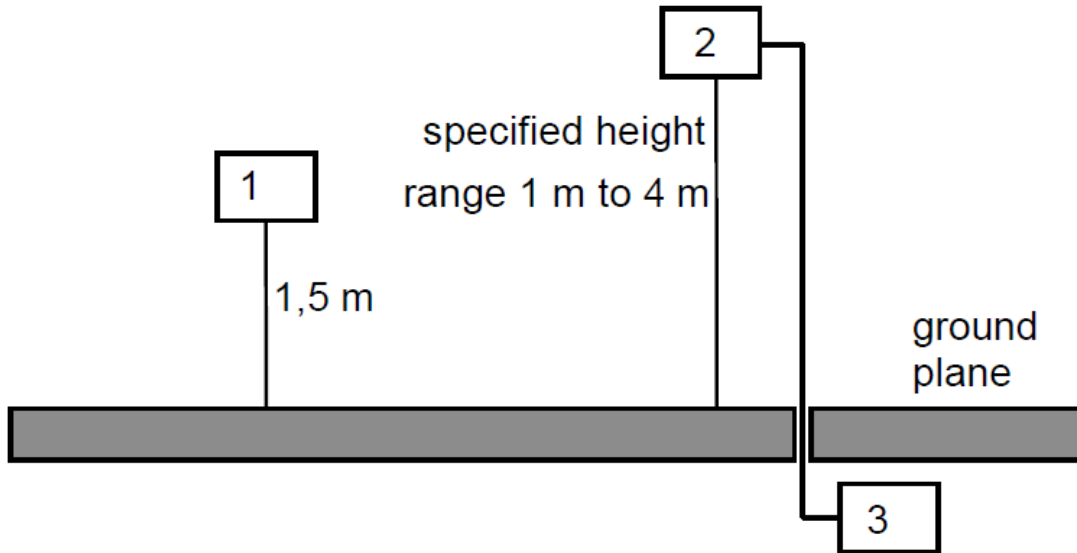

Table 1 Equipment Used in Tested System

Item	Equipment	Mfr/Brand	Model/ Type No.	Series No.	Data Cable	Power Cord
1	NB	Lenovo	X220i	NA	Non-Shielding	Non-Shielding

5.2 Test Setup for ERP/EIRP Measurement

5.2.1 Step 1. Field Strength Measurement OATS or SAR test Site



- 1) UUT
- 2) Measurement antenna
- 3) Measurement equipment

FAR Test Site

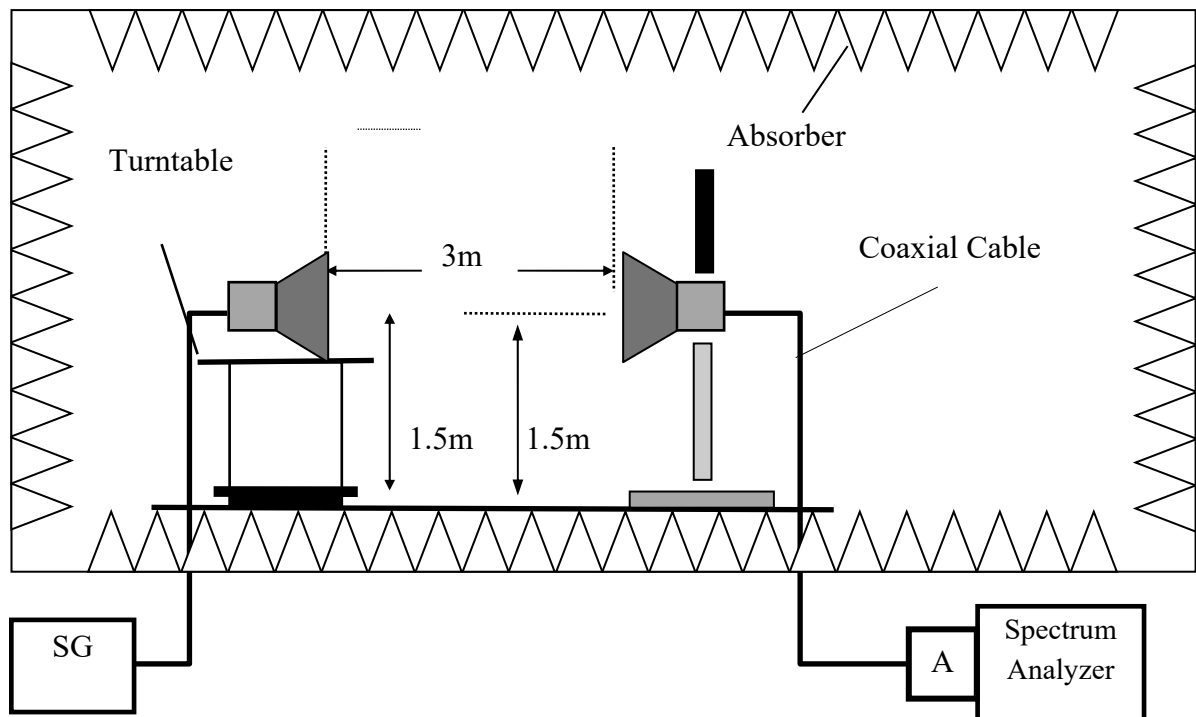

Step 2. SUBSTITUTION METHOD:

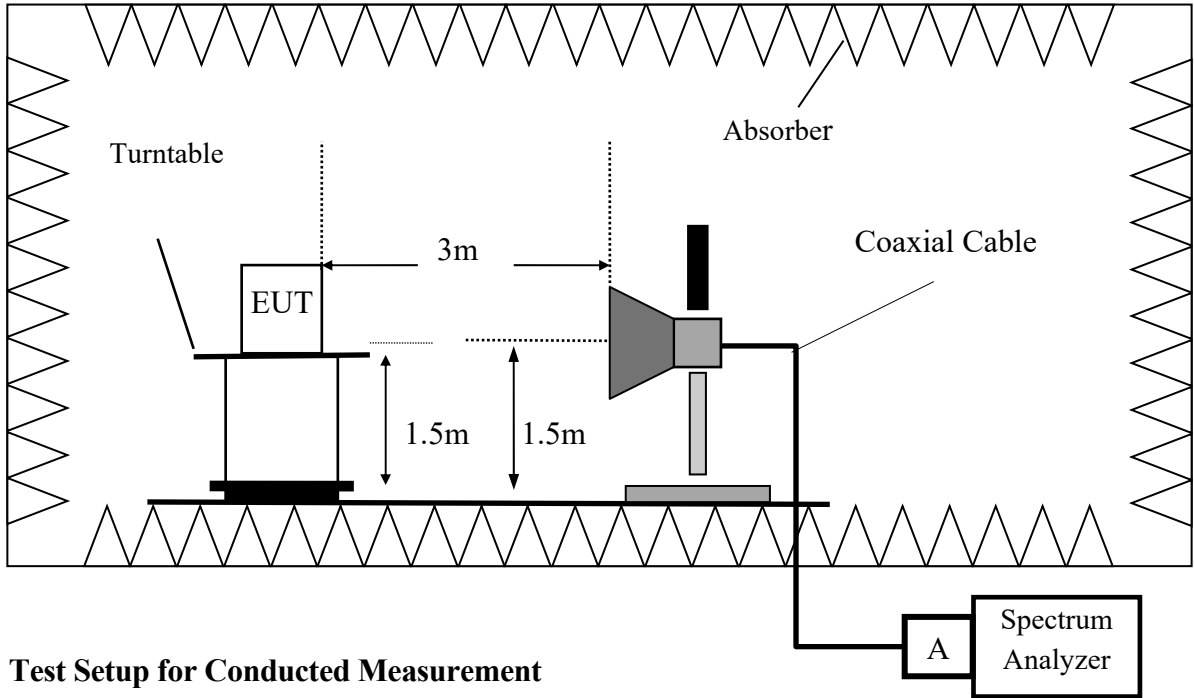

5.3 Test Setup for Conducted Measurement

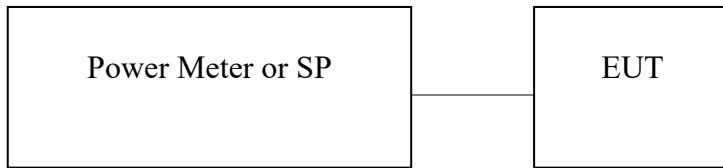

5.4 Test Setup for Extreme test

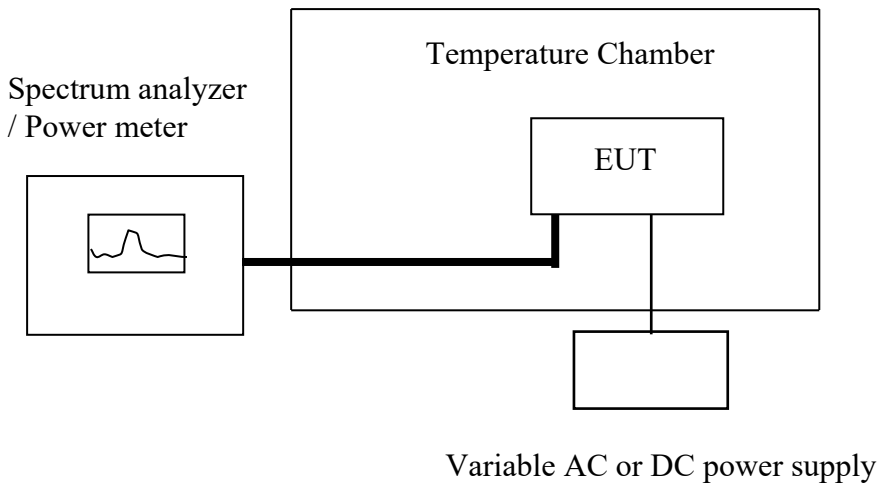

5.5 Test Setup for verifying the receiver blocking of an equipment

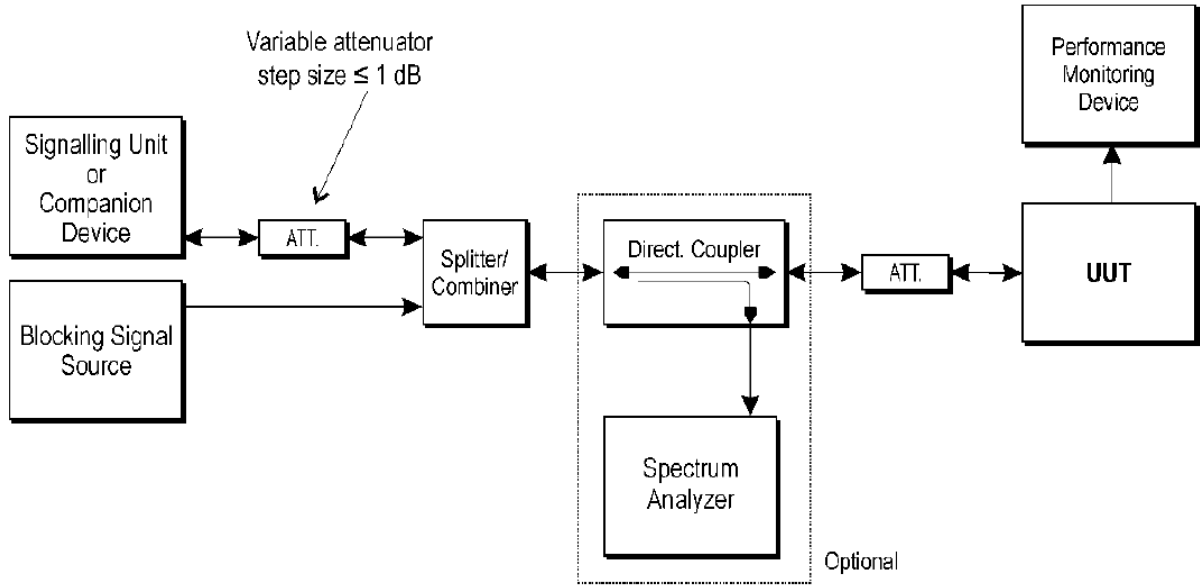

Figure 6: Test Set-up for receiver blocking

5.6 Measurement Equipment Used:

Location Conducted	Equipment Name	Brand	Model	S/N	Last Cal. Date	Next Cal. Date
Chamber 16	Spectrum Analyzer (26.5GHz)	Agilent	N9010A	MY52100117	09/02/2020	09/02/2021
Chamber 16	Dipole antenna	Schwarzbeck	VHAP,30-300	919	05/11/2020	05/11/2021
Chamber 16	Dipole antenna	Schwarzbeck	UHAP,300-1000	1195	05/11/2020	05/11/2021
Chamber 16	Loop Antenna	EM	EM-6879	271	05/21/2020	05/21/2021
Chamber 16	Bilog Antenna	Schwarzbeck	VULB9168 w 5dB Att.	9168-495	10/14/2020	10/14/2021
Chamber 16	Horn antenna (1GHz - 18GHz)	EM	EM-AH-10180	2011071401	11/23/2020	11/23/2021
Chamber 16	Horn antenna (18GHz - 26GHz)	Com-power	AH-826	081001	11/23/2020	11/23/2021
Chamber 16	Horn antenna (26GHz - 40GHz)	Com-power	AH-640	100A	03/11/2021	03/11/2022
Chamber 16	Preamplifier (9kHz - 1.3GHz)	HP	8447F	3113A04621	06/19/2020	06/19/2021
Chamber 16	Preamplifier (1GHz - 26GHz)	EM	EM01M26G	060559	05/21/2020	05/21/2021
Chamber 16	Preamplifier (26GHz - 40GHz)	MITEQ	JS4-26004000-27-5A	818471	05/04/2020	05/04/2021
Chamber 16	Cable (100kHz-1GHz)	HUBER SUHNER	Sucoflex 104A	1166 cable 001	12/25/2020	12/25/2021
Chamber 16	Cable (9kHz-18GHz)	Huber Suhner & Scube	Sucoflex 104A & CA3601-3601-L & CA3601-3601-L	50927/4A & 1166-1G-26G-01 & 1166-1G-26G-02	12/25/2020	12/25/2021
Chamber 16	Cable (18GHz-40GHz)	HUBER SUHNER	Sucoflex 102	27963/2&37421/2	11/19/2020	11/19/2021
Chamber 16	Signal Generator	Anritsu	MG3692A	20311	01/03/2021	01/03/2022
Chamber 16	Test Software	Audix	E3 Ver:6.12023	N/A	N/A	N/A

Location Conducted	Equipment Name	Brand	Model	S/N	Last Cal. Date	Next Cal. Date
Conducted	Power Meter	Anritsu	ML2495A	1116010	09/25/2020	09/25/2021
Conducted	Power Sensor	Anritsu	MA2411B	34NKF50	09/25/2020	09/25/2021
Conducted	Power Sensor	DARE	RPR3006W	13I00030SNO33	01/04/2021	01/04/2022
Conducted	Power Sensor	DARE	RPR3006W	13I00030SNO34	01/04/2021	01/04/2022
Conducted	Power Sensor	DARE	RPR3006W	14I00889SNO35	06/29/2020	06/29/2021
Conducted	Power Sensor	DARE	RPR3006W	14I00889SNO36	06/29/2020	06/29/2021
Conducted	Temperature Chamber	KSON	THS-B4H100	2287	03/11/2021	03/11/2022
Conducted	DC Power supply	ABM	8185D	N/A	01/05/2021	01/05/2022
Conducted	AC Power supply	EXTECH	CFC105W	NA	N/A	N/A
Conducted	Spectrum analyzer	Keysight	N9010A	MY56070257	09/23/2020	09/23/2021
Conducted	Test Software	DARE	Radiation Ver:2013.1.23	NA	NA	NA
Conducted	Test Software	R&S	CMUGO Ver:2.0.0	N/A	N/A	N/A
Conducted	Universal Digital Radio Communication Tester	R&S	CMU200	111968	11/29/2020	11/29/2021
Conducted	Wideband Radio Communication Tester	R&S	CMW500	1201.002K50108793-JG	10/28/2020	10/28/2021
Conducted	BT Simulator	Agilent	N4010A	MY48100200	NA	NA
Conducted	GPS Simulator	Welnavigate	GS-50	701523	NA	NA
Conducted (TS8997)	Wideband Radio Communication Tester	R&S	CMW500	168811	07/19/2020	07/19/2021
Conducted (TS8997)	Signal Generator	R&S	SMB100B	101085	10/28/2020	10/28/2021
Conducted (TS8997)	Vector Signal Generator	R&S	SMBV100A	263246	10/28/2020	10/28/2021
Conducted (TS8997)	Signal analyzer 40GHz	R&S	FSV40	101884	10/20/2020	10/20/2021
Conducted (TS8997)	OSP150 extension unit CAM-BUS	R&S	OSP150	101107	04/06/2020	04/06/2021
Conducted (TS8997)	Test Software	R&S	EMC32	NA	NA	NA

6. RF Output Power

6.1. Limit

For adaptive equipment using wide band modulations other than FHSS, the maximum RF output power shall be 20 dBm.

The maximum RF output power for non-adaptive equipment shall be declared by the supplier and shall not exceed 20 dBm. See clause 5.3.1 m). For non-adaptive equipment using wide band modulations other than FHSS, the maximum RF output power shall be equal to or less than the value declared by the supplier.

This limit shall apply for any combination of power level and intended antenna assembly.

6.2. Test Procedure

See Sub-Clause 5.4.2.1 of ETSI EN 300 328 for the test conditions

See Sub-Clause 5.4.2.2 of ETSI EN 300 328 for the test method

6.3. Test Result

Example Calculation:

Pburst values (A) = Reading + Cable Loss

RF output power (P) = A+G+Y

Ambient temperature: 25°C

Relative humidity: 60%

Test Date: 2021/02/22

Test Mode: 802.11 b

antenna assembly gain "G" in dBi

2.22 dBi

beamforming gain "Y" in dB

0.00 dB

Cable Loss=

21.00 dB

TEST CONDITIONS	TRANSMITTER POWER (dBm)		
	Lowest Frequency	Middle Frequency	Highest Frequency
Temp -40 °C	P 16.12 dBm	P 16.42 dBm	P 17.92 dBm
	A 13.90 dBm	A 14.20 dBm	A 15.70 dBm
	Reading -7.10 dBm	Reading -6.80 dBm	Reading -5.30 dBm
Temp 25 °C	P 11.72 dBm	P 11.72 dBm	P 13.42 dBm
	A 9.50 dBm	A 9.50 dBm	A 11.20 dBm
	Reading -11.50 dBm	Reading -11.50 dBm	Reading -9.80 dBm
Temp 105 °C	P 11.72 dBm	P 11.72 dBm	P 13.42 dBm
	A 9.50 dBm	A 9.50 dBm	A 11.20 dBm
	Reading -11.50 dBm	Reading -11.50 dBm	Reading -9.80 dBm
Limit(P)	20dBm		
Measurement uncertainty	+ 0.28dB / - 0.30dB		

Test Mode: 802.11 g

antenna assembly gain "G" in dBi 2.22 dBi
 beamforming gain "Y" in dB 0.00 dB
 Cable Loss= 21.00 dB

TEST CONDITIONS	TRANSMITTER POWER (dBm)		
	Lowest Frequency	Middle Frequency	Highest Frequency
Temp -40 °C	P 19.82 dBm	P 19.72 dBm	P 19.52 dBm
	A 17.60 dBm	A 17.50 dBm	A 17.30 dBm
	Reading -3.40 dBm	Reading -3.50 dBm	Reading -3.70 dBm
Temp 25 °C	P 15.72 dBm	P 15.92 dBm	P 15.52 dBm
	A 13.50 dBm	A 13.70 dBm	A 13.30 dBm
	Reading -7.50 dBm	Reading -7.30 dBm	Reading -7.70 dBm
Temp 105 °C	P 15.72 dBm	P 15.92 dBm	P 15.52 dBm
	A 13.50 dBm	A 13.70 dBm	A 13.30 dBm
	Reading -7.50 dBm	Reading -7.30 dBm	Reading -7.70 dBm
Limit(P)	20dBm		
Measurement uncertainty	+ 0.28dB / - 0.30dB		

Test Mode: 802.11n HT20

antenna assembly gain "G" in dBi	2.22 dBi
beamforming gain "Y" in dB	0.00 dB
Cable Loss=	21.00 dB

TEST CONDITIONS	TRANSMITTER POWER (dBm)					
	Lowest Frequency		Middle Frequency		Highest Frequency	
Temp -40 °C	P	19.72 dBm	P	19.92 dBm	P	19.42 dBm
	A	17.50 dBm	A	17.70 dBm	A	17.20 dBm
	Reading	-3.50 dBm	Reading	-3.30 dBm	Reading	-3.80 dBm
Temp 25 °C	P	15.52 dBm	P	15.72 dBm	P	15.32 dBm
	A	13.30 dBm	A	13.50 dBm	A	13.10 dBm
	Reading	-7.70 dBm	Reading	-7.50 dBm	Reading	-7.90 dBm
Temp 105 °C	P	15.52 dBm	P	15.72 dBm	P	15.32 dBm
	A	13.30 dBm	A	13.50 dBm	A	13.10 dBm
	Reading	-7.70 dBm	Reading	-7.50 dBm	Reading	-7.90 dBm
Limit(P)	20dBm					
Measurement uncertainty	+ 0.28dB / - 0.30dB					

Test Mode: 802.11n HT40

antenna assembly gain "G" in dBi	2.22 dBi
beamforming gain "Y" in dB	0.00 dB
Cable Loss=	21.00 dB

TEST CONDITIONS	TRANSMITTER POWER (dBm)					
	Lowest Frequency		Middle Frequency		Highest Frequency	
Temp -40 °C	P	19.82 dBm	P	19.92 dBm	P	19.62 dBm
	A	17.60 dBm	A	17.70 dBm	A	17.40 dBm
	Reading	-3.40 dBm	Reading	-3.30 dBm	Reading	-3.60 dBm
Temp 25 °C	P	16.02 dBm	P	15.82 dBm	P	15.62 dBm
	A	13.80 dBm	A	13.60 dBm	A	13.40 dBm
	Reading	-7.20 dBm	Reading	-7.40 dBm	Reading	-7.60 dBm
Temp 105 °C	P	16.02 dBm	P	15.82 dBm	P	15.62 dBm
	A	13.80 dBm	A	13.60 dBm	A	13.40 dBm
	Reading	-7.20 dBm	Reading	-7.40 dBm	Reading	-7.60 dBm
Limit(P)	20dBm					
Measurement uncertainty	+ 0.28dB / - 0.30dB					

7. Transmitter Unwanted Emissions in the Spurious Domain

7.1 Limit

This requirement applies to all types of equipment using wide band modulations other than FHSS.

The transmitter unwanted emissions in the spurious domain shall not exceed the values given in table 2.

In case of equipment with antenna connectors, these limits apply to emissions at the antenna port (conducted). For emissions radiated by the cabinet or emissions radiated by integral antenna equipment (without antenna connectors), these limits are e.r.p. for emissions up to 1 GHz and e.i.r.p. for emissions above 1 GHz.

Table 2: Transmitter limits for spurious emissions

Frequency range	Maximum power	Bandwidth
30 MHz to 47 MHz	-36 dBm	100 kHz
47 MHz to 74 MHz	-54 dBm	100 kHz
74 MHz to 87.5 MHz	-36 dBm	100 kHz
87.5 MHz to 118 MHz	-54 dBm	100 kHz
118 MHz to 174 MHz	-36 dBm	100 kHz
174 MHz to 230 MHz	-54 dBm	100 kHz
230 MHz to 470 MHz	-36 dBm	100 kHz
470 MHz to 694 MHz	-54 dBm	100 kHz
694 MHz to 1 GHz	-36 dBm	100 kHz
1 GHz to 12.75 GHz	-30 dBm	1 MHz

7.2 Test Procedure

See Sub-Clause 5.4.9.1 of ETSI EN 300 328 for the test conditions

See Sub-Clause 5.4.9.2 and 5.4.9.2.2 of ETSI EN 300 328 for Conducted Pre-Scan test method.

See Sub-Clause 5.4.9.2.2 of ETSI EN 300 328 for final Radiated test method.

7.3 Test Result

Test Mode: 802.11n HT20 mode, TX CH Low (worst case)

Ambient temperature: 25°C

Relative humidity: 60%

Test Date: 2021/02/21

No	Freq MHz	Reading dBm	Aux dB	Level dBm	Limit dBm	Margin dB	Pol V/H
1	90.25	-71.81	0.59	-72.40	-40.00	-32.40	VERTICAL
2	251.40	-75.68	4.86	-70.82	-40.00	-30.82	VERTICAL
3	514.98	-79.75	8.94	-70.81	-40.00	-30.81	VERTICAL
4	612.04	-80.61	10.62	-69.99	-40.00	-29.99	VERTICAL
5	766.40	-80.15	13.62	-66.53	-40.00	-26.53	VERTICAL
6	884.32	-82.42	16.16	-66.26	-40.00	-26.26	VERTICAL
7	4,824.00	-74.96	15.71	-90.67	-40.00	-50.67	VERTICAL
8	7,013.04	-78.96	21.94	-57.02	-40.00	-17.02	VERTICAL
1	90.95	-65.10	0.70	-65.80	-40.00	-25.80	HORIZONTAL
2	573.64	-80.35	10.61	-69.74	-40.00	-29.74	HORIZONTAL
3	658.50	-80.78	11.79	-68.99	-40.00	-28.99	HORIZONTAL
4	773.37	-80.75	14.22	-66.53	-40.00	-26.53	HORIZONTAL
5	894.20	-82.26	15.64	-66.62	-40.00	-26.62	HORIZONTAL
6	945.45	-81.06	16.91	-64.15	-40.00	-24.15	HORIZONTAL
7	4,824.00	-69.35	15.71	-85.06	-40.00	-45.06	HORIZONTAL
8	6,278.47	-77.44	19.15	-58.29	-40.00	-18.29	HORIZONTAL

Measurement uncertainty	30MHz - 80MHz: 5.04dB
	80MHz - 1000MHz: 3.76dB
	1GHz - 26GHz: 4.45dB

Remark:

1. The emission behaviors belong to narrowband spurious emission.
2. Remark " --- " means that the emission level is too low to be measured
3. Aux: Field strength to EIRP correction factor
4. Level (dBm) = Reading (dBm) + Aux (dB)
5. Measurement Range upto 12.75GHz.

Test Mode: 802.11n HT20 mode, TX CH High (worst case)

Ambient temperature: 25°C

Relative humidity: 60%

Test Date: 2021/02/21

No	Freq MHz	Reading dBm	Aux dB	Level dBm	Limit dBm	Margin dB	Pol V/H
1	97.38	-65.21	-0.23	-64.98	-40.00	-24.98	VERTICAL
2	478.51	-77.96	8.99	-68.97	-40.00	-28.97	VERTICAL
3	572.83	-81.63	9.47	-72.16	-40.00	-32.16	VERTICAL
4	654.35	-80.19	12.22	-67.97	-40.00	-27.97	VERTICAL
5	811.84	-81.31	13.78	-67.53	-40.00	-27.53	VERTICAL
6	912.11	-81.00	17.00	-64.00	-40.00	-24.00	VERTICAL
7	2,001.86	-63.67	4.63	-68.30	-40.00	-28.30	VERTICAL
8	4,944.00	-77.15	16.40	-60.75	-40.00	-20.75	VERTICAL
1	106.99	-73.23	1.11	-74.34	-40.00	-34.34	HORIZONTAL
2	282.45	-74.40	3.99	-70.41	-40.00	-30.41	HORIZONTAL
3	399.69	-78.53	6.86	-71.67	-40.00	-31.67	HORIZONTAL
4	578.00	-81.14	10.70	-70.44	-40.00	-30.44	HORIZONTAL
5	678.76	-82.01	12.15	-69.86	-40.00	-29.86	HORIZONTAL
6	796.85	-81.38	14.17	-67.21	-40.00	-27.21	HORIZONTAL
7	4,944.00	-73.30	16.40	-89.70	-40.00	-49.70	HORIZONTAL
8	7,664.21	-78.70	23.76	-54.94	-40.00	-14.94	HORIZONTAL

Measurement uncertainty	30MHz - 80MHz: 5.04dB
	80MHz -1000MHz: 3.76dB
	1GHz - 26GHz: 4.45dB

Remark:

1. The emission behaviors belong to narrowband spurious emission.
2. Remark " --- " means that the emission level is too low to be measured
3. Aux: Field strength to EIRP correction factor
4. Level (dBm) = Reading (dBm) + Aux (dB)
5. Measurement Range upto 12.75GHz.

8. Receiver Blocking

8.1 Receiver Blocking

This requirement applies to all receiver categories below.

Receiver categories

Receiver category 1

Adaptive equipment with a maximum RF output power greater than 10 dBm e.i.r.p. shall be considered as receiver category 1 equipment.

Receiver category 2

Non-adaptive equipment with a Medium Utilization (MU) factor greater than 1 % and less than or equal to 10 % or adaptive equipment with a maximum RF output power of 10 dBm e.i.r.p. shall be considered as receiver category 2 equipment.

Receiver category 3

Non-adaptive equipment with a maximum Medium Utilization (MU) factor of 1 % or adaptive equipment with a maximum RF output power of 0 dBm e.i.r.p. shall be considered as receiver category 3 equipment.

8.2 Limit

While maintaining the minimum performance criteria as defined in clause 4.3.2.11.3, the blocking levels at specified frequency offsets shall be equal to or greater than the limits defined for the applicable receiver category provided table 3, table 4 or table 5.

Table 3: Receiver Blocking parameters receiver category 1 equipment

Wanted signal mean power from companion device (dBm) (see notes 1 and 4)	Blocking signal frequency (MHz)	Blocking signal power (dBm) (see note 4)	Type of blocking signal
(-133 dBm + 10 × log ₁₀ (OCBW)) or -68 dBm whichever is less (see note 2)	2380	-34	CW
	2504		
(-139 dBm + 10 × log ₁₀ (OCBW)) or -74 dBm whichever is less (see note 3)	2300		
	2330		
	2360		
	2524		
	2584		

- NOTE 1: OCBW is in Hz.
- NOTE 2: In case of radiated measurements using a companion device and the level of the wanted signal from the companion device cannot be determined, a relative test may be performed using a wanted signal up to $P_{min} + 26$ dB where P_{min} is the minimum level of wanted signal required to meet the minimum performance criteria as defined in clause 4.3.1.12.3 in the absence of any blocking signal.
- NOTE 3: In case of radiated measurements using a companion device and the level of the wanted signal from the companion device cannot be determined, a relative test may be performed using a wanted signal up to $P_{min} + 20$ dB where P_{min} is the minimum level of wanted signal required to meet the minimum performance criteria as defined in clause 4.3.1.12.3 in the absence of any blocking signal.
- NOTE 4: The level specified is the level at the UUT receiver input assuming a 0 dBi antenna assembly gain. In case of conducted measurements, this level has to be corrected for the (in-band) antenna assembly gain (G). In case of radiated measurements, this level is equivalent to a power flux density (PFD) in front of the UUT antenna with the UUT being configured/positioned as recorded in clause 5.4.3.2.2.

Table 4: Receiver Blocking parameters receiver category 2 equipment

Wanted signal mean power from companion device (dBm) (see notes 1 and 3)	Blocking signal frequency (MHz)	Blocking signal power (dBm) (see note 3)	Type of blocking signal
$(-139 \text{ dBm} + 10 \times \log_{10}(\text{OCBW}) + 10 \text{ dB})$ or $(-74 \text{ dBm} + 10 \text{ dB})$ whichever is less (see note 2)	2380 2504 2300 2584	-34	CW
<p>NOTE 1: OCBW is in Hz.</p> <p>NOTE 2: In case of radiated measurements using a companion device and the level of the wanted signal from the companion device cannot be determined, a relative test may be performed using a wanted signal up to $P_{\text{min}} + 26 \text{ dB}$ where P_{min} is the minimum level of wanted signal required to meet the minimum performance criteria as defined in clause 4.3.1.12.3 in the absence of any blocking signal.</p> <p>NOTE 3: The level specified is the level at the UUT receiver input assuming a 0 dBi antenna assembly gain. In case of conducted measurements, this level has to be corrected for the (in-band) antenna assembly gain (G). In case of radiated measurements, this level is equivalent to a power flux density (PFD) in front of the UUT antenna with the UUT being configured/positioned as recorded in clause 5.4.3.2.2.</p>			

Table 5: Receiver Blocking parameters receiver category 3 equipment

Wanted signal mean power from companion device (dBm) (see notes 1 and 3)	Blocking signal frequency (MHz)	Blocking signal power (dBm) (see note 3)	Type of blocking signal
$(-139 \text{ dBm} + 10 \times \log_{10}(\text{OCBW}) + 20 \text{ dB})$ or $(-74 \text{ dBm} + 20 \text{ dB})$ whichever is less (see note 2)	2380 2504 2300 2584	-34	CW
<p>NOTE 1: OCBW is in Hz.</p> <p>NOTE 2: In case of radiated measurements using a companion device and the level of the wanted signal from the companion device cannot be determined, a relative test may be performed using a wanted signal up to $P_{\text{min}} + 30 \text{ dB}$ where P_{min} is the minimum level of wanted signal required to meet the minimum performance criteria as defined in clause 4.3.1.12.3 in the absence of any blocking signal.</p> <p>NOTE 3: The level specified is the level at the UUT receiver input assuming a 0 dBi antenna assembly gain. In case of conducted measurements, this level has to be corrected for the (in-band) antenna assembly gain (G). In case of radiated measurements, this level is equivalent to a power flux density (PFD) in front of the UUT antenna with the UUT being configured/positioned as recorded in clause 5.4.3.2.2.</p>			

8.3 Test Procedure

See Sub-Clause 5.4.11.1 of ETSI EN 300 328 for the test conditions

See Sub-Clause 5.4.11.2 of ETSI EN 300 328 for conducted method.

8.4 Test Result

Receiver Blocking (WIFI Lowest Channel)

Definition: Receiver blocking is a measure of the ability of the equipment to receive a wanted signal on its operating channel without exceeding a given degradation in the presence of an unwanted signal (blocking signal) on frequencies other than those of the operating band.

Summary

DUT Frequency (MHz)	Receiver Category	Companion RMS burst power (dBm)	Result
2412.000000	1	---	PASS

Measurement Overview

Blocking Frequency (MHz)	Result no Offset	Result Offset 1	Result Offset 2	Result
2380.000000	FAIL	FAIL	PASS	PASS
2300.000000	PASS	not tested	not tested	PASS
2330.000000	FAIL	PASS	not tested	PASS
2360.000000	FAIL	FAIL	PASS	PASS

Measurements

#	Blocking Frequency (MHz)	Blocking Frequency Offset (MHz)	Generator Frequency (MHz)	Blocking Level at DUT (dBm)	Generator Level (dBm)	Attenuation Generator to DUT (dB)
1	2380.000000	0.000000	2380.000000	-34.0	-4.2	29.8
2	2380.000000	10.000000	2390.000000	-34.0	-4.2	29.8
3	2380.000000	-10.000000	2370.000000	-34.0	-4.2	29.8
4	2300.000000	0.000000	2300.000000	-34.0	-4.1	29.9
5	2300.000000	20.000000	---	---	---	---
6	2300.000000	-20.000000	---	---	---	---
7	2330.000000	0.000000	2330.000000	-34.0	-4.1	29.9
8	2330.000000	20.000000	2350.000000	-34.0	-4.1	29.9
9	2330.000000	-20.000000	---	---	---	---
10	2360.000000	0.000000	2360.000000	-34.0	-4.2	29.8
11	2360.000000	20.000000	2380.000000	-34.0	-4.2	29.8
12	2360.000000	-20.000000	2340.000000	-34.0	-4.1	29.9

(continuation of the "Measurements" table from column 7 ...)

#	Level of Wanted Signal at DUT (dBm)	Wanted Level Offset (dB)	Attenuation Companion to DUT (dB)	Result
1	-68.0	0.0	49.8	FAIL
2	-65.0	3.0	49.8	FAIL
3	-71.0	-3.0	49.8	PASS
4	-74.0	0.0	49.8	PASS
5	-74.0	0.0	---	not tested
6	-74.0	0.0	---	not tested
7	-74.0	0.0	49.8	FAIL
8	-74.0	0.0	49.8	PASS
9	-74.0	0.0	---	not tested
10	-74.0	0.0	49.8	FAIL
11	-74.0	0.0	49.8	FAIL
12	-74.0	0.0	49.8	PASS

DUT Monitoring

#	Blocking Frequency (MHz)	Blocking Frequency Offset (MHz)	Name	Value	Limit Min	Limit Max	Result
1	2380.000000	0.000000	WLAN PER	45.600	---	10.000	FAIL
2	2380.000000	10.000000	WLAN PER	42.000	---	10.000	FAIL
3	2380.000000	-10.000000	WLAN PER	8.200	---	10.000	PASS
4	2300.000000	0.000000	WLAN PER	5.600	---	10.000	PASS
5	2330.000000	0.000000	WLAN PER	12.400	---	10.000	FAIL
6	2330.000000	20.000000	WLAN PER	7.200	---	10.000	PASS
7	2360.000000	0.000000	WLAN PER	33.000	---	10.000	FAIL
8	2360.000000	20.000000	WLAN PER	14.200	---	10.000	FAIL
9	2360.000000	-20.000000	WLAN PER	8.600	---	10.000	PASS

Receiver Blocking (WIFI Highest Channel)

Definition: Receiver blocking is a measure of the ability of the equipment to receive a wanted signal on its operating channel without exceeding a given degradation in the presence of an unwanted signal (blocking signal) on frequencies other than those of the operating band.

Summary

DUT Frequency (MHz)	Receiver Category	Companion RMS burst power (dBm)	Result
2472.000000	1	---	PASS

Measurement Overview

Blocking Frequency (MHz)	Result no Offset	Result Offset 1	Result Offset 2	Result
2504.000000	FAIL	FAIL	PASS	PASS
2524.000000	PASS	not tested	not tested	PASS
2584.000000	FAIL	PASS	not tested	PASS
2674.000000	PASS	not tested	not tested	PASS

Measurements

#	Blocking Frequency (MHz)	Blocking Frequency Offset (MHz)	Generator Frequency (MHz)	Blocking Level at DUT (dBm)	Generator Level (dBm)	Attenuation Generator to DUT (dB)
1	2504.000000	0.000000	2504.000000	-34.0	-4.4	29.6
2	2504.000000	10.000000	2514.000000	-34.0	-4.4	29.6
3	2504.000000	-10.000000	2494.000000	-34.0	-4.4	29.6
4	2524.000000	0.000000	2524.000000	-34.0	-4.4	29.6
5	2524.000000	20.000000	2544.000000	-34.0	-4.4	29.6
6	2524.000000	-20.000000	2504.000000	-34.0	-4.4	29.6
7	2584.000000	0.000000	2584.000000	-34.0	-4.3	29.7
8	2584.000000	20.000000	2604.000000	-34.0	-4.3	29.7
9	2584.000000	-20.000000	---	---	---	---
10	2674.000000	0.000000	2674.000000	-34.0	-4.3	29.7
11	2674.000000	20.000000	---	---	---	---
12	2674.000000	-20.000000	---	---	---	---

(continuation of the "Measurements" table from column 7 ...)

#	Level of Wanted Signal at DUT (dBm)	Wanted Level Offset (dB)	Attenuation Companion to DUT (dB)	Result
1	-68.0	0.0	50.1	FAIL
2	-71.0	-3.0	50.1	FAIL
3	-65.0	3.0	50.1	PASS
4	-74.0	0.0	50.1	PASS
5	-74.0	0.0	---	not tested
6	-74.0	0.0	---	not tested
7	-74.0	0.0	50.1	FAIL
8	-74.0	0.0	50.1	PASS
9	-74.0	0.0	---	not tested
10	-74.0	0.0	50.1	PASS
11	-74.0	0.0	---	not tested
12	-74.0	0.0	---	not tested

DUT Monitoring

#	Blocking Frequency (MHz)	Blocking Frequency Offset (MHz)	Name	Value	Limit Min	Limit Max	Result
1	2504.000000	0.000000	WLAN PER	22.400	---	10.000	FAIL
2	2504.000000	10.000000	WLAN PER	66.000	---	10.000	FAIL
3	2504.000000	-10.000000	WLAN PER	0.400	---	10.000	PASS
4	2524.000000	0.000000	WLAN PER	0.600	---	10.000	PASS
5	2524.000000	20.000000	WLAN PER	29.600	---	10.000	FAIL
6	2524.000000	-20.000000	WLAN PER	5.400	---	10.000	PASS
7	2584.000000	0.000000	WLAN PER	26.600	---	10.000	FAIL
8	2584.000000	20.000000	WLAN PER	7.000	---	10.000	PASS
9	2674.000000	0.000000	WLAN PER	7.400	---	10.000	PASS

APPENDIX 1

PHOTOGRAPHS OF SET UP

Dipole Ant

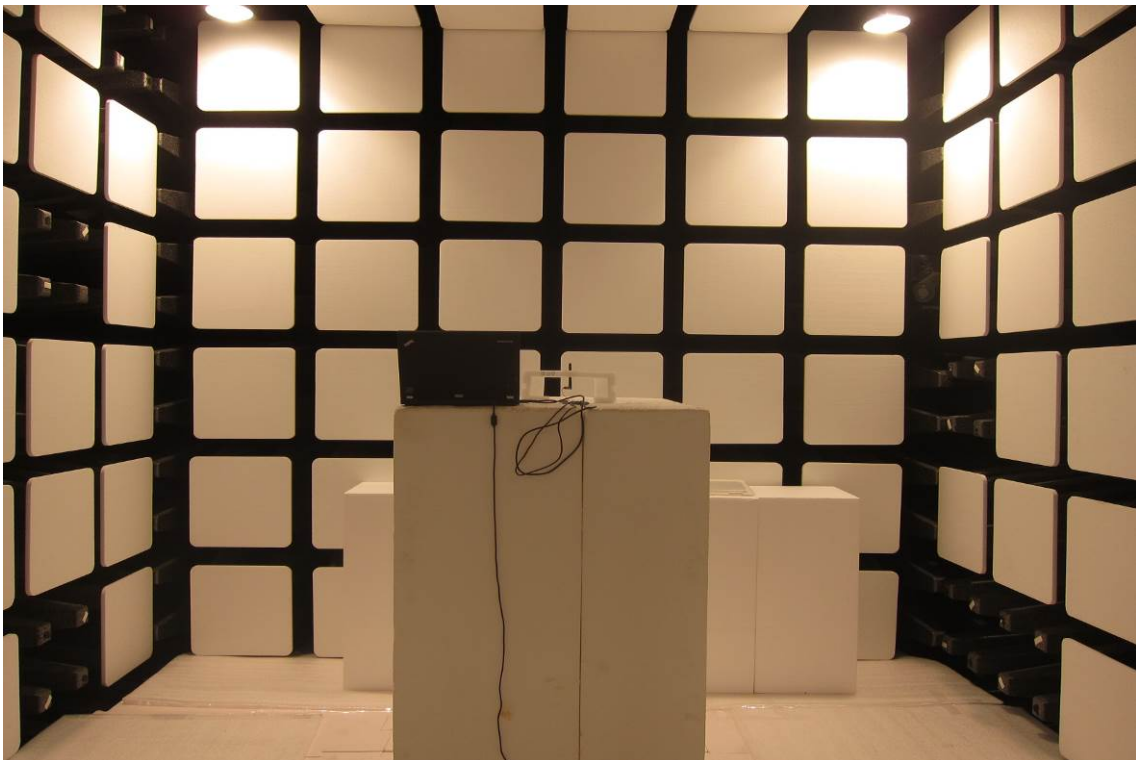

PCB Ant

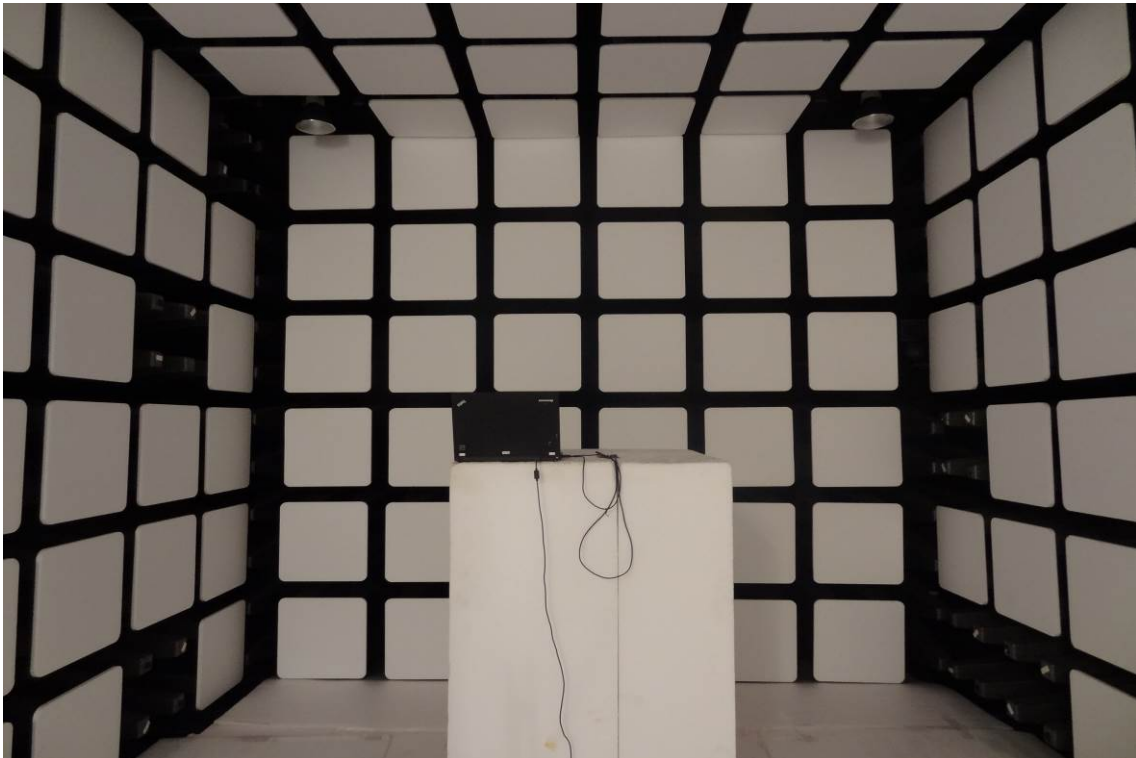
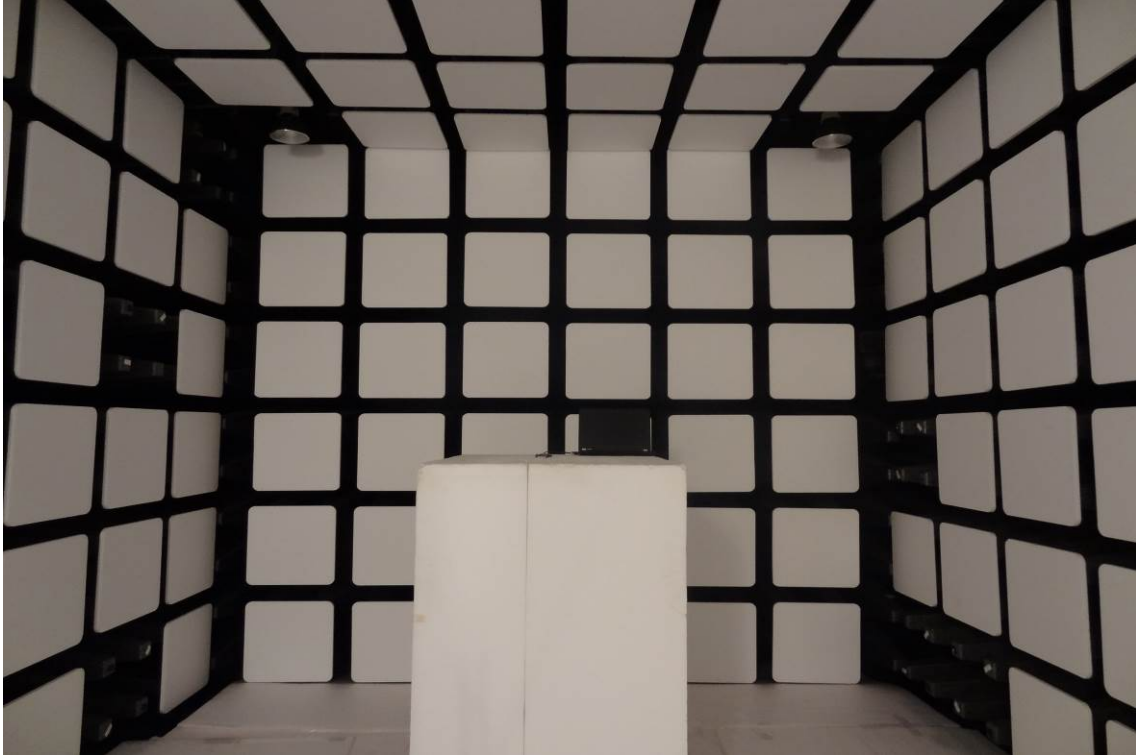

Receiver Blocking Test Setup

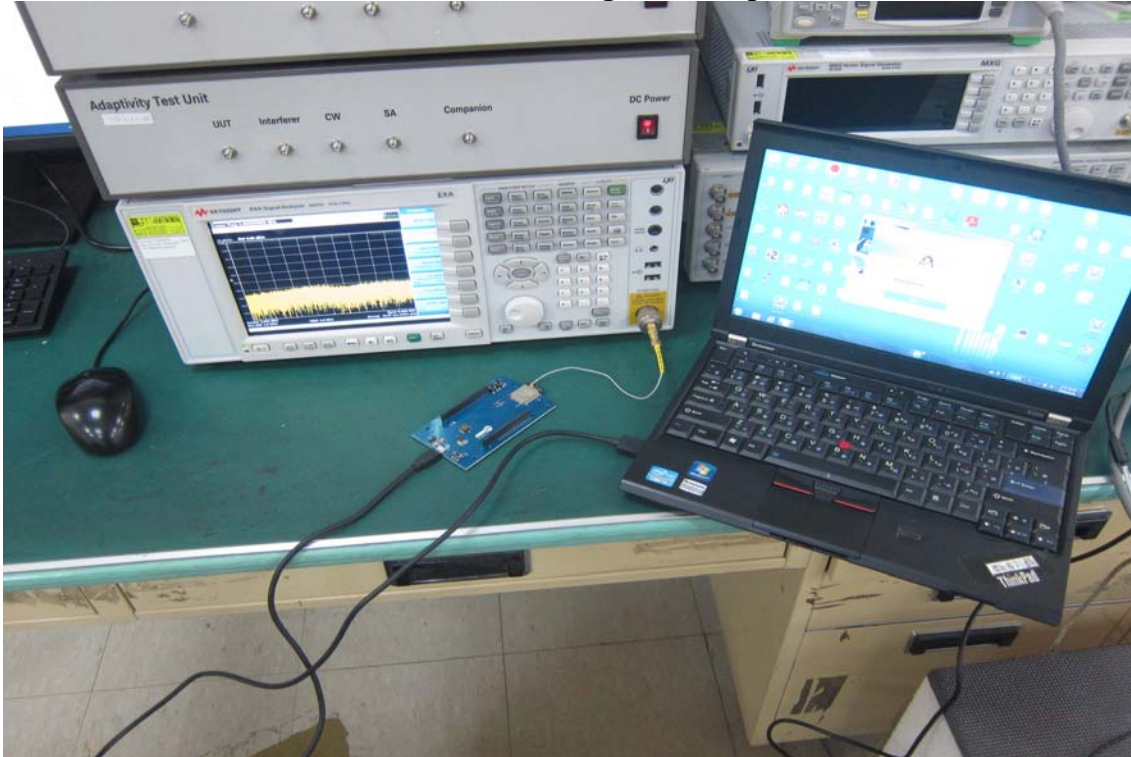

APPENDIX 2

PHOTOGRAPHS OF EUT

EUT 1

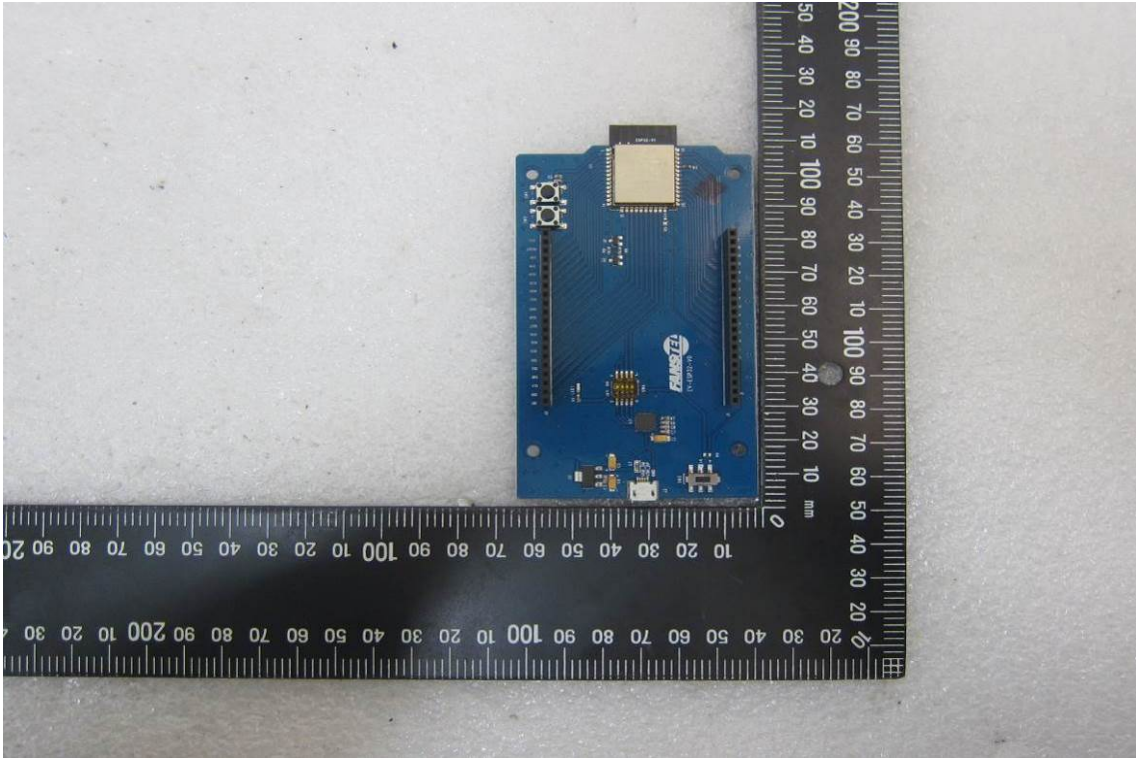

EUT 2 ESP32

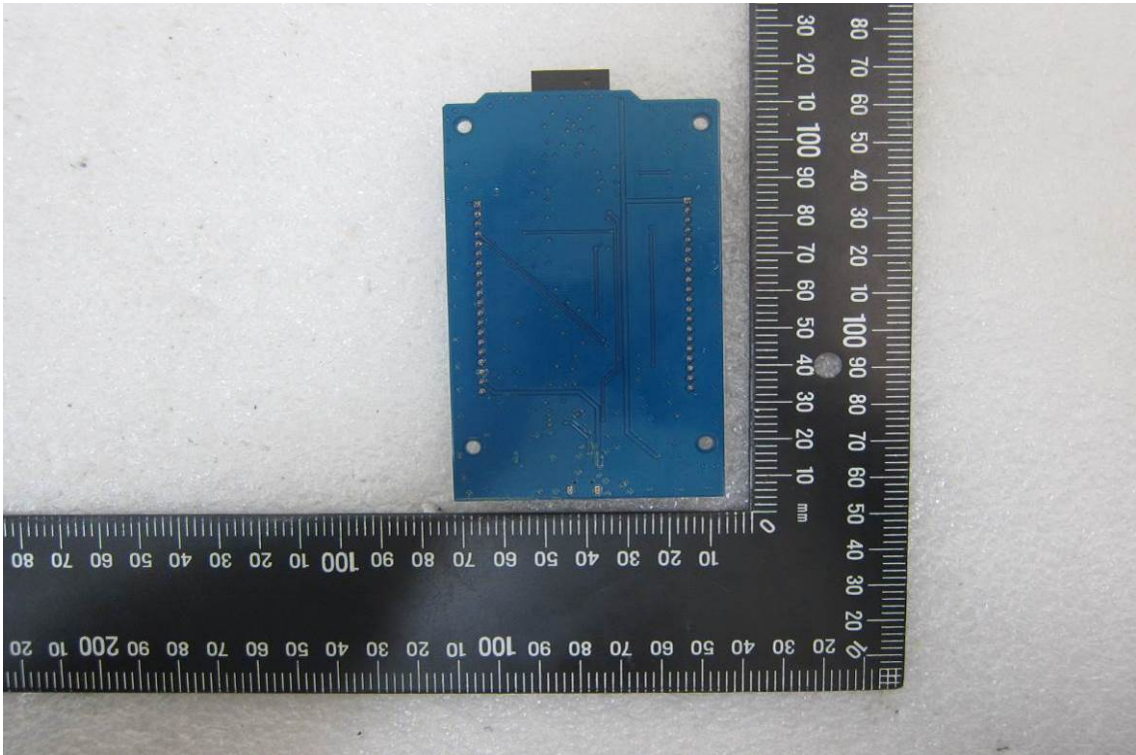

EUT 3 ESP32

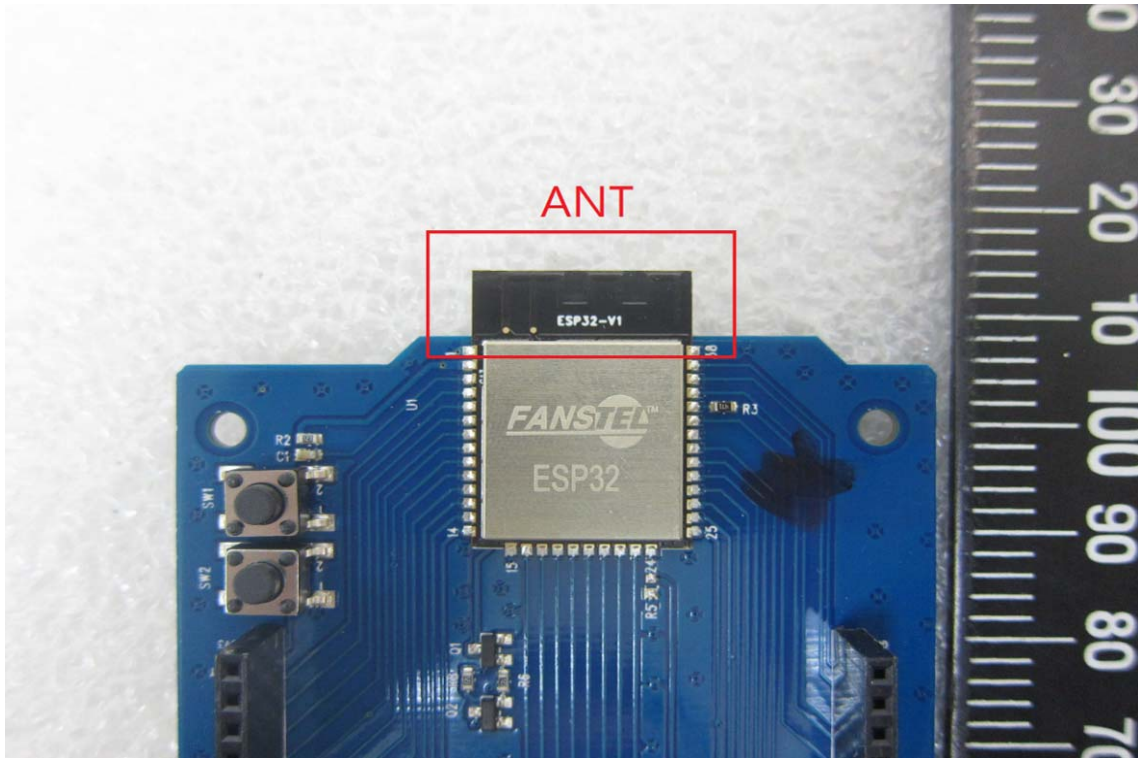

EUT 4 ESP32

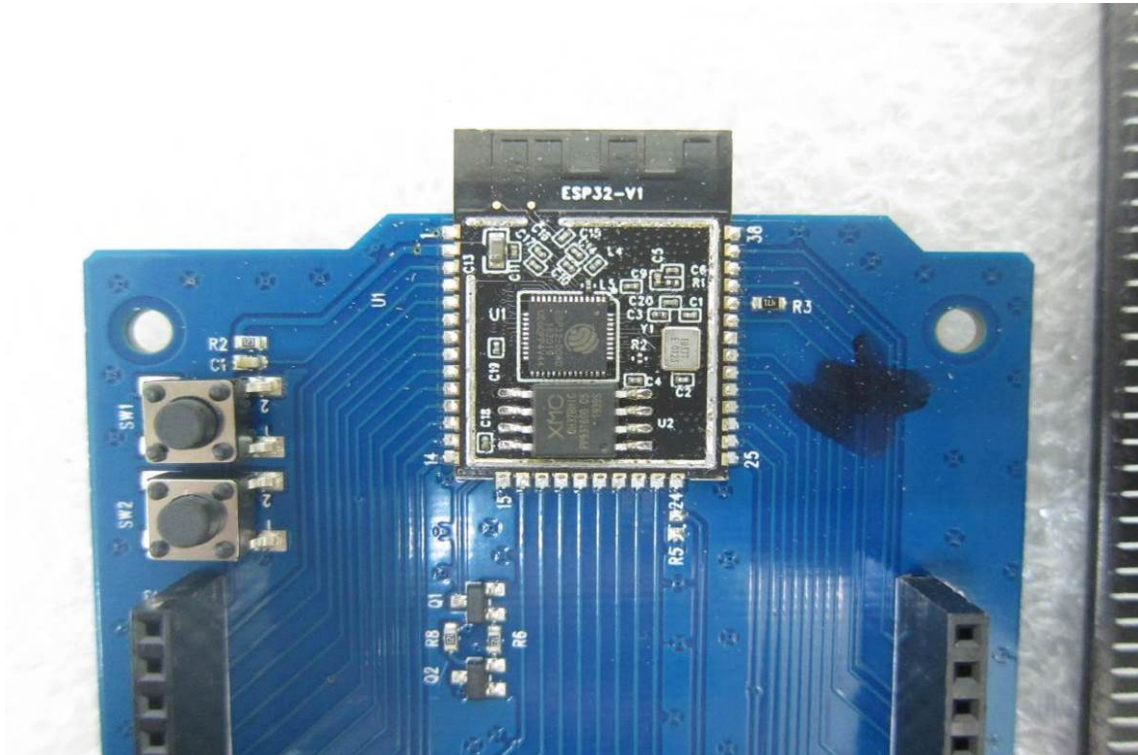

EUT 5 ESP32E

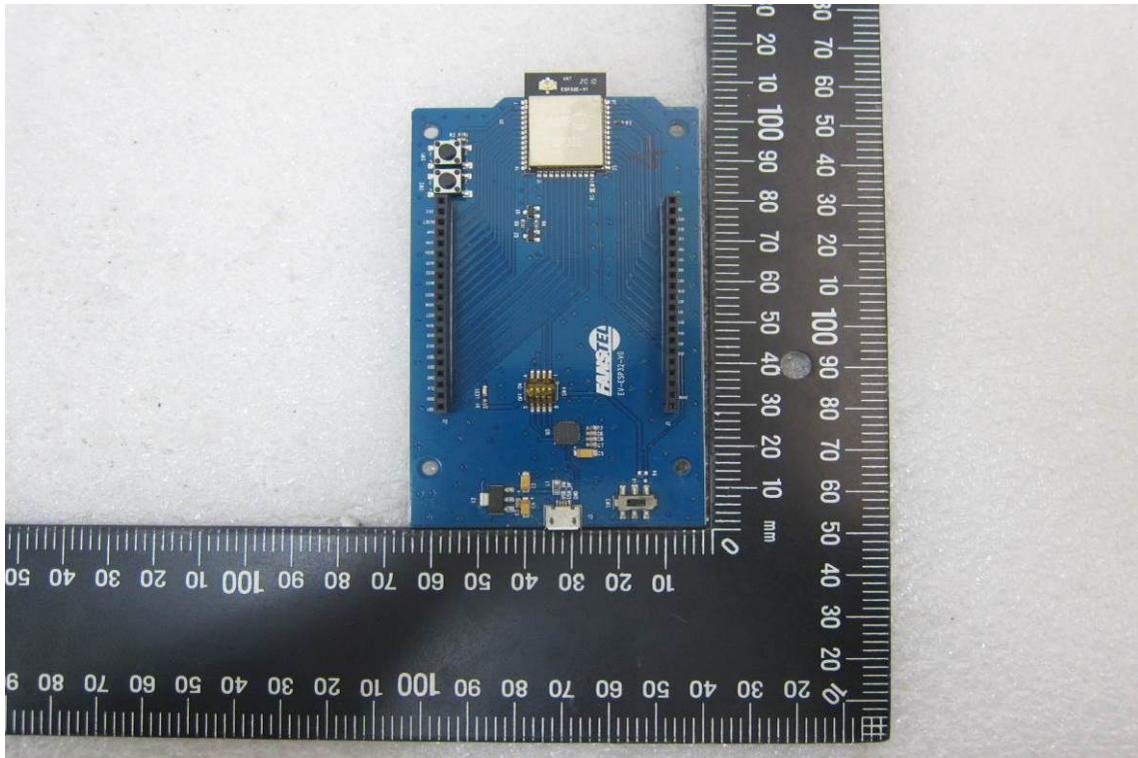

EUT 6 ESP32E

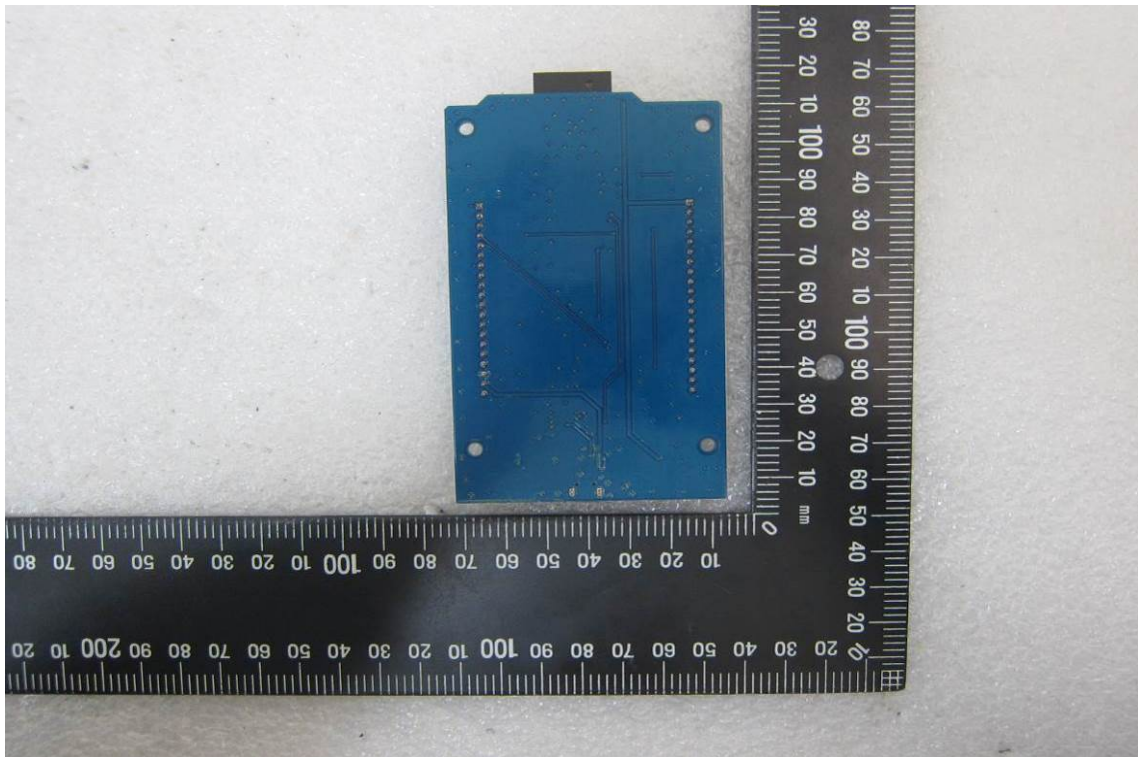

EUT 7 ESP32E



EUT 8 ESP32E



EUT 9 ESP32F

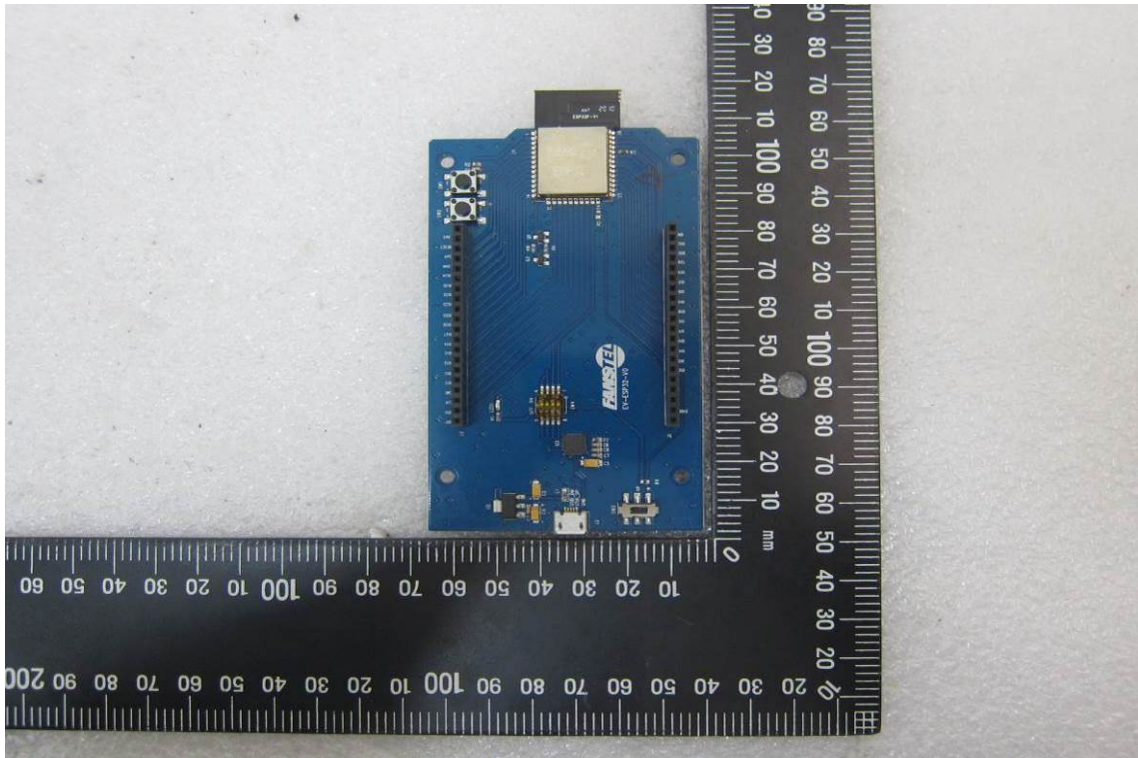

EUT 10 ESP32F

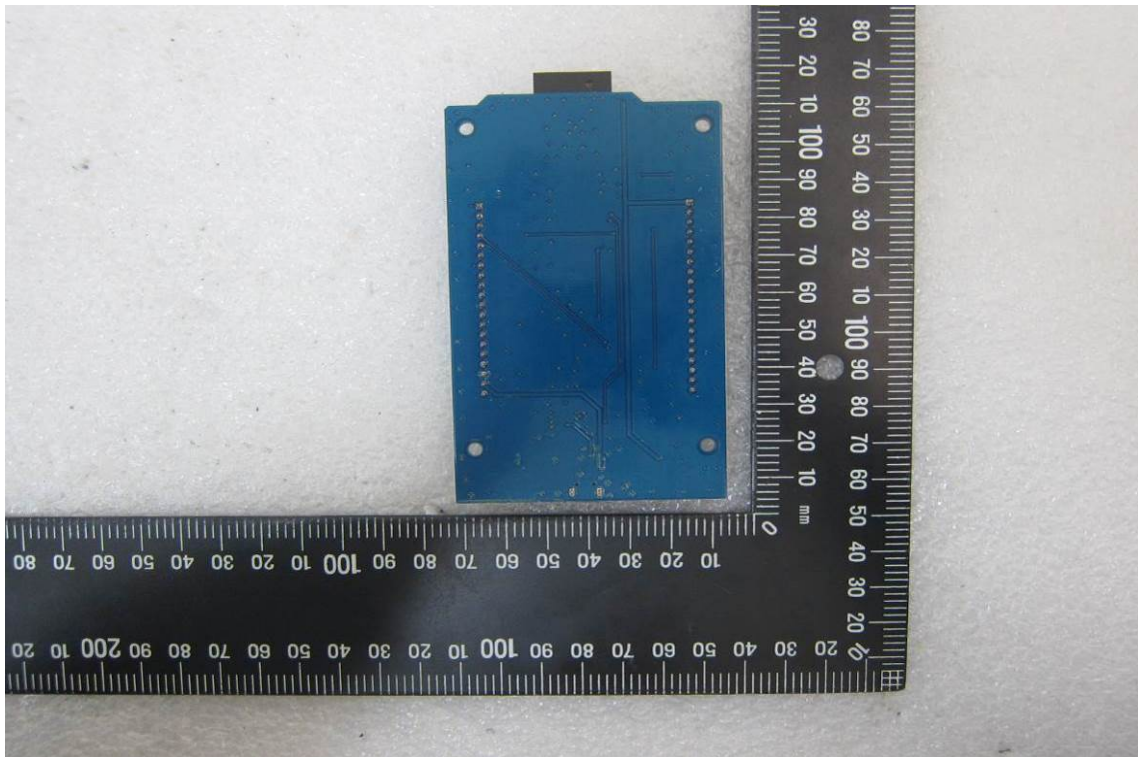

EUT 11 ESP32F

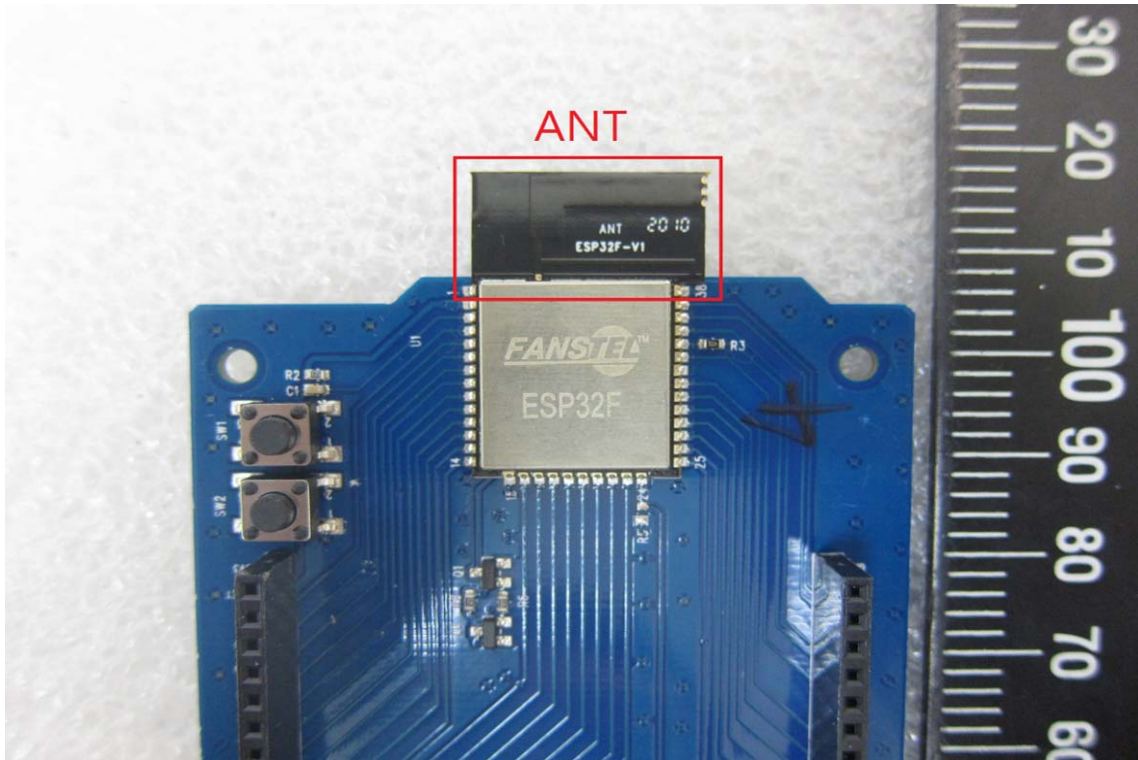

EUT 12 ESP32F



~ End of Report ~